



## Catalogue



Stat Medical Inc. is committed to providing the best in service and value to our customers.

Through innovation and dedication, Stat Medical is improving the speed and possibilities from design to delivery of quality stainless steel products, custom fabrication, and advanced shelving solutions.

Discover more at  
[www.statmedicalcanada.com](http://www.statmedicalcanada.com)

# Shelving, Racks, Carts & Specialty Shelving

Vol. 24

# Specifications

Stat Medical storage and handling equipment is uniquely designed to fit every storage application. The open wire truss-reinforced shelves permit light to penetrate, allow free air circulation and give greater visibility of merchandise. Moisture and dust accumulation is reduced and maximum effectiveness of sprinkler system is ensured. Assembly is simple. The heavy-duty tubular posts with rolled circular grooves at 1-inch increments are clearly numbered to make assembly exceptionally easy, fast and accurate. No tools are required for assembly or adjustment. The built-in tapered shelf collar mates perfectly with the inter-locking clip. The mating rib on the Stat Medical clip ensures a positive shelf position on the grooved post. A perfect fit every time!

Stat Medical Shelving has one of the highest load ratings on the market today. You asked for strong, heavy-duty shelving at an affordable price and Stat Medical answered.

## Static Load Capacity Guideline

Up to 48" wide: 1000 lbs. per shelf  
Over 48" wide: 800 lbs. per shelf  
Dunnage Shelving: 1,500 lbs. per shelf

Static load capacity is based on even distribution and can be affected by other conditions based on application – the above ratings are a guideline.

## Mobile Load Capacity Guideline

Stat Medical 5" casters have a load capacity rating of 300 lbs. each. Mobile load capacities are application based – as a guideline, complete mobile units should not carry more than 3 to 4 times the individual caster rating.

## Tailored to Your Needs: Custom Shelving Solutions Available!

At Stat Medical, we understand that every space is unique, which is why we offer custom sizes and finishes to suit your specific requirements. Whether you need shelves to fit an unconventional space or crave a personalized touch with a distinct finish, we've got you covered.

Please note that while we strive for excellence in both craftsmanship and customization, extended lead times may apply for bespoke orders. Contact us today to discuss your vision, and let's bring your shelving dreams to life!

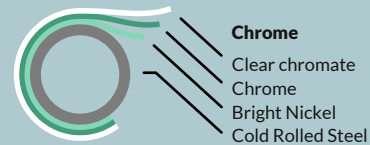
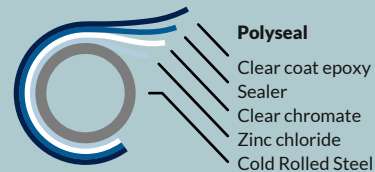

Our shelving systems come in a variety of finishes. Choose the one that is best for your application and budget.

## Stainless Steel

Crafted from 304 series stainless steel, this material stands as the pinnacle choice for a variety of applications, ensuring durability and sleek aesthetics.

## Polyseal

Seeking unparalleled protection? Opt for our shelves featuring a Polyseal finish. With a clear epoxy powder coat applied electrostatically over a base of bright zinc-chromate electroplating, these shelves excel in various storage settings, including high-humidity environments like refrigeration. Enjoy extended longevity and corrosion resistance, backed by a limited 15-year corrosion warranty. Terms and conditions apply.

## Chrome

Prioritizing aesthetics? Our chrome-finished units are a prime selection. Boasting a brilliant nickel-chrome electroplating, these shelves elevate visual appeal, making them ideal for dry storage and display applications. With these shelves, aesthetics truly shine, complemented by a one-year warranty.

## Epoxy

Electrostatically applied, our Epoxy finish combines durability with versatility. Standard in black and available in various colors, these shelves offer a blend of reliability and affordability, backed by a three-year warranty from the date of manufacture.

# The strongest shelf

## Take a Load Off

With the unparalleled strength of Stat Medical's wire shelving.

1. Unlike some manufacturers, Stat Medical makes the connection. Stat Medical's trusses are always connected to the perimeter truss, which significantly reduces deflection and bowing in all standard shelf configurations.



2. Stat Medical provides more top mat wires than most competitors in the industry, resulting in a shelf with superior strength!



3. Support rods are foundational to the strength of any shelf, which is why Stat Medical only manufactures support rods that are thick, strong, and secure.



## We Have Other Strengths, Too!

4. Numbered posts simplify the process of installation and ensure that shelves are assembled accurately the first time, every time.

5. Offering a complete line of shelving, Stat Medical is your one-stop supplier for any and all shelving needs. No need to source from multiple manufacturers!

6. Traditional hex post levellers have been replaced by an upgraded, non-marking leveller as part of our standard offering.

7. While some manufacturers may offer low grade, cheaper casters, these can greatly reduce shelf capacity and ruin flooring. High-capacity, non-marking polyurethane casters are our standard, as we refuse to compromise the quality or capacity of our shelving.

8. With our consistently high warehouse stock, you can bet that we will have what you need when you need it.



## Myth

High-humidity environments like walk-in refrigerators or hothouses need green shelving to protect against rust and corrosion.

## Fact

While many manufacturers market green shelving as the gold standard for humid environments, the green is purely cosmetic and was developed as nothing more than a visual aid to help users differentiate between shelving for humid environments and standard shelving. Because of this association, many have come to believe that they need green shelves in high-humidity environments and have even fallen victim to purchasing unsuitable shelving simply because the units were green.

When it comes to corrosion resistance, what really matters is the material that the shelves are comprised of, which is why our Polyseal shelves have four corrosion-fighting layers, including a unique zinc chromate undercoat that keeps our units free of rust and corrosion for years of intensive use. Why else would we offer a 15-year corrosion warranty?

# Shelves

## Wire Shelves

Stat Medical has the strongest shelf in the industry. Featuring connected trusses, thicker support wires, more wire per square foot of shelf.

A variety of sizes and finishes to choose from, plastic clips included.

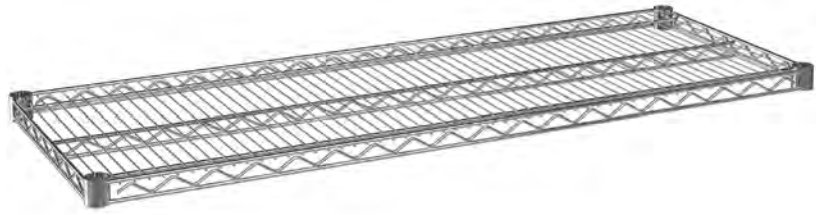

**Load Capacity Per Shelf: Up to 48": 1000 lbs - Over 48": 800 lbs**

| Size<br>D" x L" | Polyseal<br>Model No. | Chrome<br>Model No. | Stainless Steel<br>Model No. | Black Epoxy<br>Model No. | Weight<br>lbs. |
|-----------------|-----------------------|---------------------|------------------------------|--------------------------|----------------|
| 12x24           | TS-S1224Z             | TS-S1224C           | TS-S1224S                    | TS-S1224EB               | 5              |
| 14x24           | TS-S1424Z             | TS-S1424C           | TS-S1424S                    | TS-S1424EB               | 6              |
| 14x30           | TS-S1430Z             | TS-S1430C           | TS-S1430S                    | TS-S1430EB               | 7              |
| 14x36           | TS-S1436Z             | TS-S1436C           | TS-S1436S                    | TS-S1436EB               | 8              |
| 14x42           | TS-S1442Z             | TS-S1442C           | TS-S1442S                    | TS-S1442EB               | 9.5            |
| 14x48           | TS-S1448Z             | TS-S1448C           | TS-S1448S                    | TS-S1448EB               | 10.5           |
| 14x54           | TS-S1454Z             | TS-S1454C           | TS-S1454S                    | TS-S1454EB               | 12             |
| 14x60           | TS-S1460Z             | TS-S1460C           | TS-S1460S                    | TS-S1460EB               | 14             |
| 14x66           | TS-S1466Z             | TS-S1466C           | TS-S1466S                    | TS-S1466EB               | 15.5           |
| 14x72           | TS-S1472Z             | TS-S1472C           | TS-S1472S                    | TS-S1472EB               | 17             |
| 18x18           | TS-S1818Z             | TS-S1818C           | TS-S1818S                    | TS-S1818EB               | 6              |
| 18x24           | TS-S1824Z             | TS-S1824C           | TS-S1824S                    | TS-S1824EB               | 7              |
| 18x30           | TS-S1830Z             | TS-S1830C           | TS-S1830S                    | TS-S1830EB               | 8              |
| 18x36           | TS-S1836Z             | TS-S1836C           | TS-S1836S                    | TS-S1836EB               | 9.5            |
| 18x42           | TS-S1842Z             | TS-S1842C           | TS-S1842S                    | TS-S1842EB               | 11             |
| 18x48           | TS-S1848Z             | TS-S1848C           | TS-S1848S                    | TS-S1848EB               | 12             |
| 18x54           | TS-S1854Z             | TS-S1854C           | TS-S1854S                    | TS-S1854EB               | 14.5           |
| 18x60           | TS-S1860Z             | TS-S1860C           | TS-S1860S                    | TS-S1860EB               | 17             |
| 18x66           | TS-S1866Z             | TS-S1866C           | TS-S1866S                    | TS-S1866EB               | 18.5           |
| 18x72           | TS-S1872Z             | TS-S1872C           | TS-S1872S                    | TS-S1872EB               | 20             |
| 21x18           | TS-S2118Z             | TS-S2118C           | TS-S2118S                    | TS-S2118EB               | 8              |
| 21x24           | TS-S2124Z             | TS-S2124C           | TS-S2124S                    | TS-S2124EB               | 8              |
| 21x30           | TS-S2130Z             | TS-S2130C           | TS-S2130S                    | TS-S2130EB               | 9              |
| 21x36           | TS-S2136Z             | TS-S2136C           | TS-S2136S                    | TS-S2136EB               | 11             |
| 21x42           | TS-S2142Z             | TS-S2142C           | TS-S2142S                    | TS-S2142EB               | 12             |
| 21x48           | TS-S2148Z             | TS-S2148C           | TS-S2148S                    | TS-S2148EB               | 14             |
| 21x54           | TS-S2154Z             | TS-S2154C           | TS-S2154S                    | TS-S2154EB               | 16             |
| 21x60           | TS-S2160Z             | TS-S2160C           | TS-S2160S                    | TS-S2160EB               | 18             |
| 21x66           | TS-S2166Z             | TS-S2166C           | TS-S2166S                    | TS-S2166EB               | 20             |
| 21x72           | TS-S2172Z             | TS-S2172C           | TS-S2172S                    | TS-S2172EB               | 22             |
| 24x24           | TS-S2424Z             | TS-S2424C           | TS-S2424S                    | TS-S2424EB               | 9              |
| 24x30           | TS-S2430Z             | TS-S2430C           | TS-S2430S                    | TS-S2430EB               | 11             |
| 24x36           | TS-S2436Z             | TS-S2436C           | TS-S2436S                    | TS-S2436EB               | 13             |
| 24x42           | TS-S2442Z             | TS-S2442C           | TS-S2442S                    | TS-S2442EB               | 15             |
| 24x48           | TS-S2448Z             | TS-S2448C           | TS-S2448S                    | TS-S2448EB               | 16             |
| 24x54           | TS-S2454Z             | TS-S2454C           | TS-S2454S                    | TS-S2454EB               | 19             |
| 24x60           | TS-S2460Z             | TS-S2460C           | TS-S2460S                    | TS-S2460EB               | 21             |
| 24x66           | TS-S2466Z             | TS-S2466C           | TS-S2466S                    | TS-S2466EB               | 23.5           |
| 24x72           | TS-S2472Z             | TS-S2472C           | TS-S2472S                    | TS-S2472EB               | 26             |

## Wire Shelves

| Size<br>D" x L" | Polyseal<br>Model No. | Chrome<br>Model No. | Stainless Steel<br>Model No. | Black Epoxy<br>Model No. | Weight<br>lbs. |
|-----------------|-----------------------|---------------------|------------------------------|--------------------------|----------------|
| 30x30           | TS-S3030Z             | TS-S3030C           | TS-S3030S                    | TS-S3030EB               | 13             |
| 30x36           | TS-S3036Z             | TS-S3036C           | TS-S3036S                    | TS-S3036EB               | 15             |
| 30x42           | TS-S3042Z             | TS-S3042C           | TS-S3042S                    | TS-S3042EB               | 16             |
| 30x48           | TS-S3048Z             | TS-S3048C           | TS-S3048S                    | TS-S3048EB               | 18             |
| 30x54           | TS-S3054Z             | TS-S3054C           | TS-S3054S                    | TS-S3054EB               | 23             |
| 30x60           | TS-S3060Z             | TS-S3060C           | TS-S3060S                    | TS-S3060EB               | 25             |
| 30x66           | TS-S3066Z             | TS-S3066C           | TS-S3066S                    | TS-S3066EB               | 28             |
| 30x72           | TS-S3072Z             | TS-S3072C           | TS-S3072S                    | TS-S3072EB               | 32             |
| 36x36           | TS-S3636Z             | TS-S3636C           | TS-S3636S                    | TS-S3636EB               | 22             |
| 36x48           | TS-S3648Z             | TS-S3648C           | TS-S3648S                    | TS-S3648EB               | 24             |
| 36x60           | TS-S3660Z             | TS-S3660C           | TS-S3660S                    | TS-S3660EB               | 26             |
| 36x72           | TS-S3672Z             | TS-S3672C           | TS-S3672S                    | TS-S3672EB               | 30             |
| 42x30           | TS-S4230Z             | TS-S4230C           | TS-S4230S                    | TS-S4230EB               | 16             |
| 42x36           | TS-S4236Z             | TS-S4236C           | TS-S4236S                    | TS-S4236EB               | 20             |
| 42x42           | TS-S4242Z             | TS-S4242C           | TS-S4242S                    | TS-S4242EB               | 22             |
| 42x48           | TS-S4248Z             | TS-S4248C           | TS-S4248S                    | TS-S4248EB               | 24             |
| 42x54           | TS-S4254Z             | TS-S4254C           | TS-S4254S                    | TS-S4254EB               | 26             |

## Post



Stat Medical Shelf Posts, measuring 54" and above, are meticulously numbered for effortless identification. Each post is equipped with adjustable leveling bolts and a top post cap, ensuring versatile and stable shelf assembly. Crafted from durable one-inch round steel tubing, these posts feature grooves at one-inch increments, facilitating seamless and convenient setup.

**In need of something custom?  
Contact us for custom post  
heights or custom epoxy colors.**

| Size<br>H" | Polyseal<br>Model No. | Chrome<br>Model No. | Stainless Steel<br>Model No. | Black Epoxy<br>Model No. | Weight<br>lbs. |
|------------|-----------------------|---------------------|------------------------------|--------------------------|----------------|
| 6          | TS-P6Z                | TS-P6C              | TS-P6S                       | TS-P6EB                  | 0.5            |
| 14         | TS-P14Z               | TS-P14C             | TS-P14S                      | TS-P14EB                 | 1              |
| 26         | TS-P26Z               | TS-P26C             | TS-P26S                      | TS-P26EB                 | 2              |
| 28         | TS-P28Z               | TS-P28C             | TS-P28S                      | TS-P28EB                 | 2              |
| 34         | TS-P34Z               | TS-P34C             | TS-P34S                      | TS-P34EB                 | 3              |
| 54         | TS-P54Z               | TS-P54C             | TS-P54S                      | TS-P54EB                 | 3.5            |
| 63         | TS-P63Z               | TS-P63C             | TS-P63S                      | TS-P63EB                 | 4              |
| 69         | TS-P69Z               | TS-P69C             | TS-P69S                      | TS-P69EB                 | 4              |
| 74         | TS-P74Z               | TS-P74C             | TS-P74S                      | TS-P74EB                 | 4.5            |
| 81         | TS-P81Z               | TS-P81C             | TS-P81S                      | TS-P81EB                 | 5              |
| 86         | TS-P86Z               | TS-P86C             | TS-P86S                      | TS-P86EB                 | 5              |
| 96         | TS-P96Z               | TS-P96C             | TS-P96S                      | TS-P96EB                 | 6              |

# Casters

## Stem Casters

Polyurethane non-marking stem casters are designed to fit easily and securely into Stat Medical posts, adding mobility to stationary units. Each caster has a load rating of 300 lbs., ensuring reliable performance. Choose between threaded stem casters, suitable for even surfaces, and non-threaded stem casters, ideal for uneven surfaces, to meet your specific needs with confidence.

| Size Inches                      | Swivel Model No. | Swivel w/Brake Model No. |
|----------------------------------|------------------|--------------------------|
| <b>Threaded Stem Casters</b>     |                  |                          |
| 3                                | TS-C3SPS         | TS-C3SPB                 |
| 4                                | TS-C4SPS         | TS-C4SPB                 |
| 5                                | TS-C5SPS         | TS-C5SPB                 |
| <b>Non-Threaded Stem Casters</b> |                  |                          |
| 5                                | TS-C5STSP        | TS-C5STSPB               |



## Plate Casters

Plate Casters feature non-marking Polyurethane construction, ensuring smooth and effortless movement. These casters are specifically designed for use with dolly bases, offering enhanced mobility and convenience. See page 26 for more details.

| Size Inches | Swivel Model No. | Swivel w/Brake Model No. |
|-------------|------------------|--------------------------|
| 5           | TS-C5PPS         | TS-C5PPSB                |
| 6           | TS-C6PPS         | TS-C6PPSB                |



## Rigid Casters

Constructed with non-marking Polyurethane, our Rigid Casters provide sturdy support and smooth mobility. Designed for use with Tie Bar systems. Refer to Catalogue F for further details.

| Size Inches | Model No. |
|-------------|-----------|
| 5"          | TS-C5SPR  |



## Donut Bumper

Featuring non-marking Polyurethane construction, specially designed to protect walls from damage.

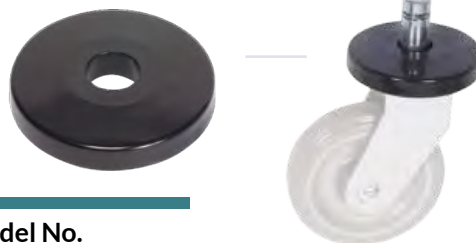

| Size Inches | Model No. |
|-------------|-----------|
| 3½"         | TS-DB     |

Fits all stem style casters

If you need shelving that can adapt to diverse floor surfaces or withstand all-weather/all-terrain applications, look no further. Contact us today to explore our custom dolly base options tailored to your specific shelving unit. Whether it's rough terrain or unique flooring, we've got you covered with a solution that ensures stability and mobility wherever you need it

## Flex Mount Shelving

For intermediate storage needs with frequent shelf adjustments, consider Flex Mount shelves. Standard wire shelves must be used at the top and bottom tiers to provide rigidity.



| Size D" x L" | Polyseal Model No. | Weight lbs. |
|--------------|--------------------|-------------|
| 18x30        | TS-SFM1830Z        | 8           |
| 18x36        | TS-SFM1836Z        | 9.5         |
| 18x48        | TS-SFM1848Z        | 12          |
| 18x60        | TS-SFM1860Z        | 17          |
| 24x36        | TS-SFM2436Z        | 13          |
| 24x42        | TS-SFM2442Z        | 15          |
| 24x48        | TS-SFM2448Z        | 16          |
| 24x54        | TS-SFM2454Z        | 19          |
| 24x60        | TS-SFM2460Z        | 21          |

**Additional sizes available.**  
May require a minimum quantity ordered. Order posts separately.

## The Corner Conqueror

Stat Medical's 5-sided shelf maximizes space utilization with its unique design, perfect for tapping into unused corner space. Shelf sizes correspond to the width of shelving, allowing for seamless add-on capability.



| Size D" x L" | Polyseal Model No. | Weight lbs. |
|--------------|--------------------|-------------|
| 18x36        | TS-S51836Z         | 12          |
| 21x36        | TS-S52136Z         | 14          |
| 24x42        | TS-S52442Z         | 18          |
| 31x34        | TS-S5183134L       | 16          |
| 31x34        | TS-S5183134R       | 16          |

A complete unit requires 5 posts, to be ordered separately

## Triangular Shelf

Utilize unused corner space efficiently with the Triangular Shelf. Designed to match the width of shelving for easy integration with Add-Ons, it maximizes storage potential in any corner.



| Size D" | Chrome Model No. | Weight lbs. |
|---------|------------------|-------------|
| 18      | TS-ST18C         | 7           |
| 24      | TS-ST24C         | 10          |

## Quarter Round Shelf

Tailored for showcasing products, the Quarter Round Shelf offers the benefits of a triangular shelf with added aesthetic appeal, thanks to its radius truss design. Perfect for enhancing your display aesthetics and showcasing products with style.

| Size D" | Chrome Model No. | Weight lbs. |
|---------|------------------|-------------|
| 18      | TS-SQ18C         | 7.5         |
| 24      | TS-SQ24C         | 10.5        |



## Round Shelf

Stat Medical's round shelves offer a unique way to showcase your products. With their curved design, these shelves create visual interest while maximizing display space.

| Size D" x L" | Model No. | Weight lbs. |
|--------------|-----------|-------------|
| 24x4.5       | TS-SR24C  | 5           |

A complete unit requires 3 posts, to be ordered separately

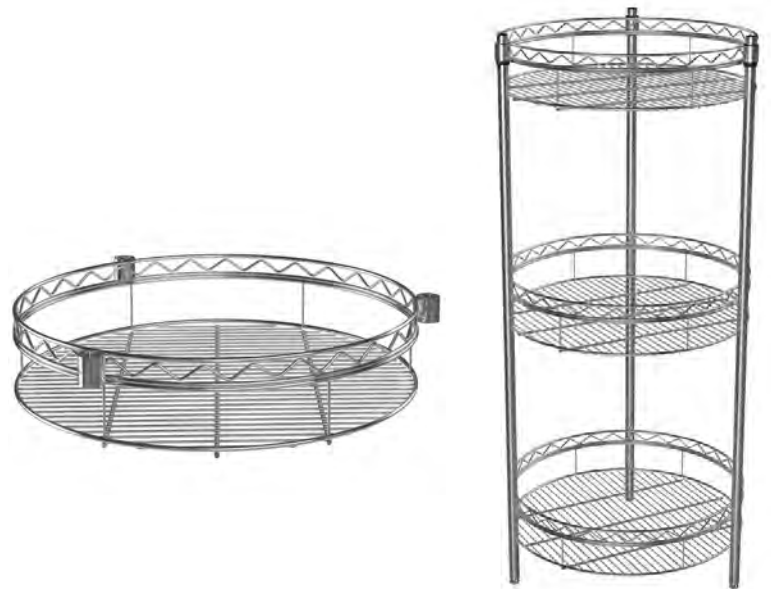

## Solid Stainless Steel Shelf

Crafted from heavy-duty stainless steel, our Solid Stainless Steel Shelf offers unparalleled durability and strength.

| Size D" x L" | Stainless Steel Model No. | Weight lbs. |
|--------------|---------------------------|-------------|
| 18x36        | TS-S1836SS                | 16          |
| 18x48        | TS-S1848SS                | 24          |
| 18x60        | TS-S1860SS                | 26          |
| 24x36        | TS-S2436SS                | 31          |
| 24x42        | TS-S2442SS                | 36          |
| 24x48        | TS-S2448SS                | 41          |
| 24x60        | TS-S2460SS                | 48          |
| 24x72        | TS-S2472SS                | 62          |
| 30x36        | TS-S3036SS                | 40          |
| 30x48        | TS-S3048SS                | 54          |

Additional sizes available.  
May require a minimum order quantity





## Super Duty Shelf

Our Super Duty Shelf seamlessly merges the practicality of traditional wire mat shelving with the robustness of square tube dunnage shelving. Ideal as a bottom shelf for high-volume, heavy-load applications, it ensures unparalleled durability. With a square tube truss every six inches, this shelving offers maximum support for your heaviest items. Available in standard listed sizes, with custom sizes also available upon request (minimum order quantity applies).

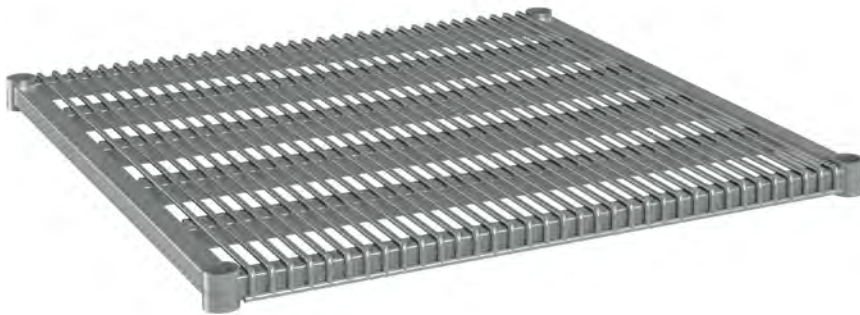

| Size D" x L" | Polyseal Model No. | Weight lbs. |
|--------------|--------------------|-------------|
| 18x36        | TS-SDF41836Z       | 16          |
| 18x48        | TS-SDF41848Z       | 21          |
| 21x36        | TS-SDF42136Z       | 19          |
| 21x42        | TS-SDF42142Z       | 22          |
| 21x48        | TS-SDF42148Z       | 25          |
| 24x36        | TS-SDF42436Z       | 22          |
| 24x42        | TS-SDF42442Z       | 26          |
| 24x48        | TS-SDF42448Z       | 30          |
| 24x54        | TS-SDF42454Z       | 33          |
| 24x60        | TS-SDF42460Z       | 38          |
| 24x72        | TS-SDF42472Z       | 42          |
| 30x30        | TS-SDF43030Z       | 23          |
| 30x36        | TS-SDF43036Z       | 28          |
| 30x42        | TS-SDF43042Z       | 32          |
| 30x48        | TS-SDF43048Z       | 37          |
| 30x54        | TS-SDF43054Z       | 41          |
| 42x36        | TS-SDF44236Z       | 38          |
| 42x42        | TS-SDF44242Z       | 44          |
| 42x48        | TS-SDF44248Z       | 51          |
| 42x54        | TS-SDF44254Z       | 57          |

## 3-Sided Frame

The 3-Sided Frame is designed to enhance the strength, stability, and structural integrity of your shelving unit. Constructed of 1" square tubing, it ensures reliable support for your storage needs.

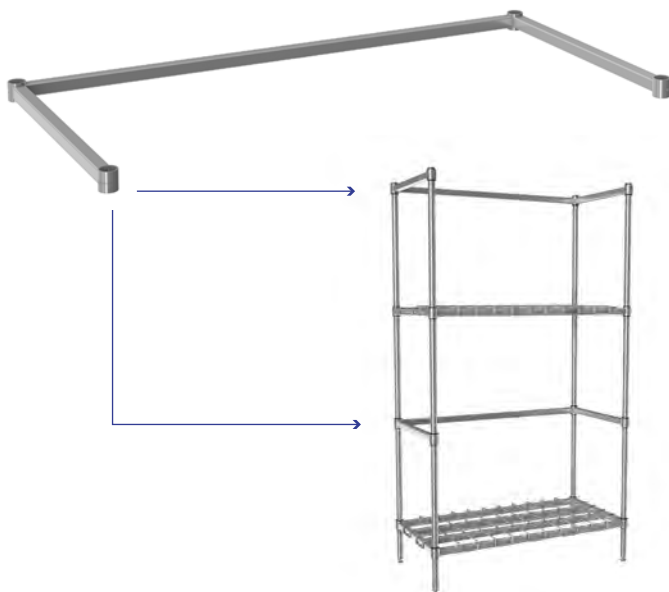

| Size D" x L" | Polyseal Model No. | Weight lbs. |
|--------------|--------------------|-------------|
| 18x24        | TS-DF1824Z         | 5           |
| 18x30        | TS-DF1830Z         | 6           |
| 18x36        | TS-DF1836Z         | 7           |
| 18x42        | TS-DF1842Z         | 8           |
| 18x48        | TS-DF1848Z         | 8           |
| 18x60        | TS-DF1860Z         | 9           |
| 18x72        | TS-DF1872Z         | 12          |
| 24x24        | TS-DF2424Z         | 6           |
| 24x30        | TS-DF2430Z         | 7           |
| 24x36        | TS-DF2436Z         | 8           |
| 24x42        | TS-DF2442Z         | 9           |
| 24x48        | TS-DF2448Z         | 10          |
| 24x54        | TS-DF2454Z         | 11          |
| 24x60        | TS-DF2460Z         | 12          |
| 24x66        | TS-DF2466Z         | 13          |
| 24x72        | TS-DF2472Z         | 14          |

Chrome version available with minimum order quantity and extended time.

## Channel Dunnage Shelf

Perfect for heavy duty dunnage applications, providing an ideal solution for storing bagged and cased goods. With a shelf capacity of up to 1,500 lbs., it offers sturdy support for your heaviest items. Constructed with 1" square steel tubing, this shelf ensures durability and reliability. For added strength on longer lengths, consider our Dunnage Rack Centre Support available on page 18. Ideal as a bottom shelf on shelving units, the Channel Dunnage Shelf is your go-to choice for robust storage solutions.

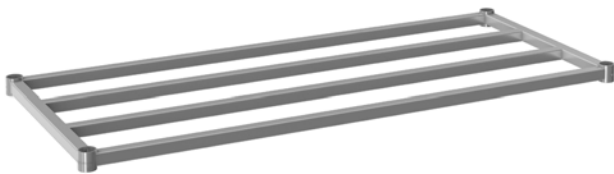

| Size D" x L" | Polyseal Model No. | Weight lbs. |
|--------------|--------------------|-------------|
| 14x36        | TS-DF41436Z        | 8           |
| 14x48        | TS-DF41448Z        | 9           |
| 18x24        | TS-DF41824Z        | 7           |
| 18x30        | TS-DF41830Z        | 8           |
| 18x36        | TS-DF41836Z        | 9           |
| 18x42        | TS-DF41842Z        | 10          |
| 18x48        | TS-DF41848Z        | 11          |
| 18x54        | TS-DF41854Z        | 12          |
| 18x60        | TS-DF41860Z        | 14          |
| 18x66        | TS-DF41866Z        | 16          |
| 18x72        | TS-DF41872Z        | 18          |
| 21x24        | TS-DF42124Z        | 9           |
| 21x30        | TS-DF42130Z        | 11          |
| 21x36        | TS-DF42136Z        | 13          |
| 21x42        | TS-DF42142Z        | 14          |
| 21x48        | TS-DF42148Z        | 17          |
| 21x54        | TS-DF42154Z        | 19          |
| 21x60        | TS-DF42160Z        | 21          |
| 24x24        | TS-DF42424Z        | 8           |
| 24x30        | TS-DF42430Z        | 10          |
| 24x36        | TS-DF42436Z        | 12          |
| 24x42        | TS-DF42442Z        | 14          |
| 24x48        | TS-DF42448Z        | 16          |
| 24x54        | TS-DF42454Z        | 18          |
| 24x60        | TS-DF42460Z        | 20          |
| 24x66        | TS-DF42466Z        | 22          |
| 24x72        | TS-DF42472Z        | 24          |
| 30x48        | TS-DF43048Z        | 27          |
| 42x30        | TS-DF44230Z        | 21          |
| 42x42        | TS-DF44242Z        | 30          |
| 42x48        | TS-DF44248Z        | 33          |
| 42x54        | TS-DF44254Z        | 37          |

## Dunnage Shelf Mat

This removable optional mesh wire decking enhances the shelf's durability, providing sturdy support for your items. Its unique grid design allows for the storage of smaller items, ensuring efficient organization within your storage space.

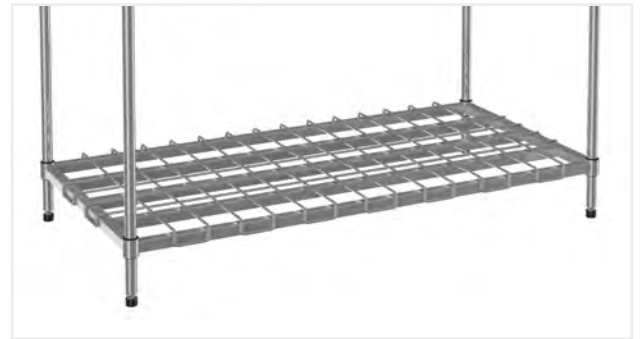
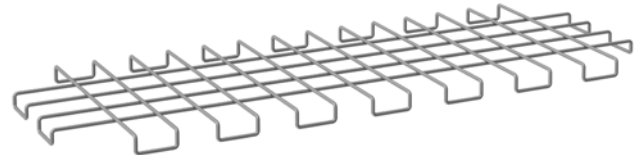

| Size D" x L" | Polyseal Model No. | Weight lbs. |
|--------------|--------------------|-------------|
| 18x24        | TS-DWM1824Z        | 5           |
| 18x30        | TS-DWM1830Z        | 5           |
| 18x36        | TS-DWM1836Z        | 6           |
| 18x42        | TS-DWM1842Z        | 7           |
| 18x48        | TS-DWM1848Z        | 8           |
| 18x54        | TS-DWM1854Z        | 10          |
| 18x60        | TS-DWM1860Z        | 12          |
| 18x66        | TS-DWM1866Z        | 14          |
| 18x72        | TS-DWM1872Z        | 16          |
| 24x24        | TS-DWM2424Z        | 5           |
| 24x30        | TS-DWM2430Z        | 6           |
| 24x36        | TS-DWM2436Z        | 7           |
| 24x42        | TS-DWM2442Z        | 8           |
| 24x48        | TS-DWM2448Z        | 9           |
| 24x54        | TS-DWM2454Z        | 12          |
| 24x60        | TS-DWM2460Z        | 14          |
| 24x66        | TS-DWM2466Z        | 15          |
| 24x72        | TS-DWM2472Z        | 17          |

Chrome version available with minimum order quantity and extended lead time.

# Shelves

## Starter Unit

Start with a Stat Medical Starter Unit, comprising four numbered posts, four shelves, and plastic clips. Effortlessly transform these units into mobile carts by adding four polyurethane stem casters.

What sets Stat Medical apart? Unlike some manufacturers, Stat Medical makes the connection. Stat Medical's trusses are always connected to the perimeter truss, which significantly reduces deflection and bowing in all standard shelf configurations.

### Load Capacity Per Shelf

Up to 48": 1000 lbs  
Over 48": 800 lbs



Contact us for custom orders

## Starter Units

| Size    | 63" High Unit      |                  | 74" High Unit      |                  | 86" High Unit      |                  | Weight           |
|---------|--------------------|------------------|--------------------|------------------|--------------------|------------------|------------------|
| D" x L" | Polyseal Model No. | Chrome Model No. | Polyseal Model No. | Chrome Model No. | Polyseal Model No. | Chrome Model No. | lbs. 63"/74"/86" |
| 14x24   | TS-14246Z          | TS-14246C        | TS-14247Z          | TS-14247C        | TS-14248Z          | TS-14248C        | 38/40/44         |
| 14x30   | TS-14306Z          | TS-14306C        | TS-14307Z          | TS-14307C        | TS-14308Z          | TS-14308C        | 42/44/48         |
| 14x36   | TS-14366Z          | TS-14366C        | TS-14367Z          | TS-14367C        | TS-14368Z          | TS-14368C        | 46/48/52         |
| 14x42   | TS-14426Z          | TS-14426C        | TS-14427Z          | TS-14427C        | TS-14428Z          | TS-14428C        | 52/54/58         |
| 14x48   | TS-14486Z          | TS-14486C        | TS-14487Z          | TS-14487C        | TS-14488Z          | TS-14488C        | 58/60/64         |
| 14x54   | TS-14546Z          | TS-14546C        | TS-14547Z          | TS-14547C        | TS-14548Z          | TS-14548C        | 62/64/68         |
| 14x60   | TS-14606Z          | TS-14606C        | TS-14607Z          | TS-14607C        | TS-14608Z          | TS-14608C        | 72/74/78         |
| 14x66   | TS-14666Z          | TS-14666C        | TS-14667Z          | TS-14667C        | TS-14668Z          | TS-14668C        | 82/84/88         |
| 14x72   | TS-14726Z          | TS-14726C        | TS-14727Z          | TS-14727C        | TS-14728Z          | TS-14728C        | 88/90/94         |
| 18x18   | TS-18186Z          | TS-18186C        | TS-18187Z          | TS-18187C        | TS-18188Z          | TS-18188C        | 40/42/46         |
| 18x24   | TS-18246Z          | TS-18246C        | TS-18247Z          | TS-18247C        | TS-18248Z          | TS-18248C        | 42/44/48         |
| 18x30   | TS-18306Z          | TS-18306C        | TS-18307Z          | TS-18307C        | TS-18308Z          | TS-18308C        | 46/48/52         |
| 18x36   | TS-18366Z          | TS-18366C        | TS-18367Z          | TS-18367C        | TS-18368Z          | TS-18368C        | 52/54/58         |
| 18x42   | TS-18426Z          | TS-18426C        | TS-18427Z          | TS-18427C        | TS-18428Z          | TS-18428C        | 58/60/64         |
| 18x48   | TS-18486Z          | TS-18486C        | TS-18487Z          | TS-18487C        | TS-18488Z          | TS-18488C        | 62/64/68         |
| 18x54   | TS-18546Z          | TS-18546C        | TS-18547Z          | TS-18547C        | TS-18548Z          | TS-18548C        | 72/74/78         |
| 18x60   | TS-18606Z          | TS-18606C        | TS-18607Z          | TS-18607C        | TS-18608Z          | TS-18608C        | 82/84/88         |
| 18x66   | TS-18666Z          | TS-18666C        | TS-18667Z          | TS-18667C        | TS-18668Z          | TS-18668C        | 88/90/94         |
| 18x72   | TS-18726Z          | TS-18726C        | TS-18727Z          | TS-18727C        | TS-18728Z          | TS-18728C        | 94/96/100        |
| 21x24   | TS-21246Z          | TS-21246C        | TS-21247Z          | TS-21247C        | TS-21248Z          | TS-21248C        | 46/48/52         |
| 21x30   | TS-21306Z          | TS-21306C        | TS-21307Z          | TS-21307C        | TS-21308Z          | TS-21308C        | 50/52/56         |
| 21x36   | TS-21366Z          | TS-21366C        | TS-21367Z          | TS-21367C        | TS-21368Z          | TS-21368C        | 58/60/64         |
| 21x42   | TS-21426Z          | TS-21426C        | TS-21427Z          | TS-21427C        | TS-21428Z          | TS-21428C        | 62/64/68         |
| 21x48   | TS-21486Z          | TS-21486C        | TS-21487Z          | TS-21487C        | TS-21488Z          | TS-21488C        | 70/72/76         |
| 21x54   | TS-21546Z          | TS-21546C        | TS-21547Z          | TS-21547C        | TS-21548Z          | TS-21548C        | 78/80/84         |
| 21x60   | TS-21606Z          | TS-21606C        | TS-21607Z          | TS-21607C        | TS-21608Z          | TS-21608C        | 86/88/92         |
| 21x66   | TS-21666Z          | TS-21666C        | TS-21667Z          | TS-21667C        | TS-21668Z          | TS-21668C        | 98/100/104       |
| 21x72   | TS-21726Z          | TS-21726C        | TS-21727Z          | TS-21727C        | TS-21728Z          | TS-21728C        | 110/112/116      |
| 24x24   | TS-24246Z          | TS-24246C        | TS-24247Z          | TS-24247C        | TS-24248Z          | TS-24248C        | 50/52/56         |
| 24x30   | TS-24306Z          | TS-24306C        | TS-24307Z          | TS-24307C        | TS-24308Z          | TS-24308C        | 58/60/64         |
| 24x36   | TS-24366Z          | TS-24366C        | TS-24367Z          | TS-24367C        | TS-24368Z          | TS-24368C        | 66/68/72         |
| 24x42   | TS-24426Z          | TS-24426C        | TS-24427Z          | TS-24427C        | TS-24428Z          | TS-24428C        | 74/76/80         |
| 24x48   | TS-24486Z          | TS-24486C        | TS-24487Z          | TS-24487C        | TS-24488Z          | TS-24488C        | 78/80/84         |
| 24x54   | TS-24546Z          | TS-24546C        | TS-24547Z          | TS-24547C        | TS-24548Z          | TS-24548C        | 90/92/96         |
| 24x60   | TS-24606Z          | TS-24606C        | TS-24607Z          | TS-24607C        | TS-24608Z          | TS-24608C        | 98/100/104       |
| 24x66   | TS-24666Z          | TS-24666C        | TS-24667Z          | TS-24667C        | TS-24668Z          | TS-24668C        | 108/118/124      |
| 24x72   | TS-24726Z          | TS-24726C        | TS-24727Z          | TS-24727C        | TS-24728Z          | TS-24728C        | 118/120/124      |

1

Choose your size (Including height)

3

Add additional shelves on page 4 and 5A or Add-on units on page 14

2

Choose your finish

4

Create a mobile unit with Stem Casters on page 6

# Shelves

Load Capacity Per Shelf: Up to 48": 1000 lbs - Over 48": 800 lbs

## Corner Starter Unit

Conquer the corner with Stat Medical's 5-sided Corner Starter Units. Designed to enhance corner accessibility, these units are perfect for optimizing storage in tight spaces. Each Corner Starter Unit includes five posts, four 5-sided shelves, and plastic clips for easy assembly.

Looking to expand further? Check out our Add-on Units on page 14 for additional storage solutions.



| Size    | 63" High Unit      |                  | 74" High Unit      |                  | 86" High Unit      |                  | Weight |
|---------|--------------------|------------------|--------------------|------------------|--------------------|------------------|--------|
| D" x L" | Polyseal Model No. | Chrome Model No. | Polyseal Model No. | Chrome Model No. | Polyseal Model No. | Chrome Model No. | lbs.   |
| 18x36   | TS-518366Z         | TS-518366C       | TS-518367Z         | TS-518367C       | TS-518368Z         | TS-518368C       | 68     |
| 21x36   | TS-521366Z         | TS-521366C       | TS-521367Z         | TS-521367C       | TS-521368Z         | TS-521368C       | 79     |
| 24x42   | TS-524426Z         | TS-524426C       | TS-524427Z         | TS-524427C       | TS-524428Z         | TS-524428C       | 97     |

**When placing your order, please be sure to include the -KIT suffix to the model number**



## 5-Sided Shelf

| Model No. |            | Dimensions (inches) |    |    |    | Weight Lbs. |
|-----------|------------|---------------------|----|----|----|-------------|
|           |            | A                   | B  | C  | D  |             |
| Chrome    | TS-S51836C | 18                  | 36 | 24 | 38 | 12          |
| Chrome    | TS-S52136C | 21                  | 36 | 20 | 40 | 14          |
| Chrome    | TS-S52442C | 24                  | 42 | 24 | 46 | 18          |
| Polyseal  | TS-S51836Z | 18                  | 36 | 24 | 38 | 12          |
| Polyseal  | TS-S52136Z | 21                  | 36 | 20 | 40 | 14          |
| Polyseal  | TS-S52442Z | 24                  | 42 | 24 | 46 | 18          |

| Model No. |              | Dimensions (inches) |    |    |    |    | Weight Lbs. |
|-----------|--------------|---------------------|----|----|----|----|-------------|
|           |              | A                   | B  | C  | D  | E  |             |
| Polyseal  | TS-S5183134L | 18                  | 31 | 20 | 34 | 34 | 16          |
| Polyseal  | TS-S5183134R | 18                  | 31 | 20 | 34 | 34 | 16          |

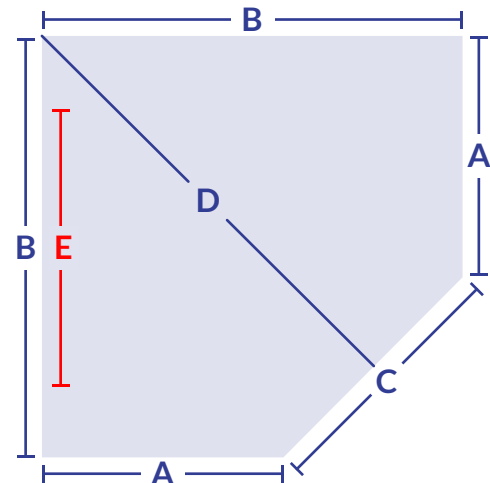

## Add-On Unit

Expand your storage space effortlessly with Add-On Units. Each unit includes two posts, four shelves, plastic clips, and eight S-Hooks. The innovative S-Hook design eliminates the need to purchase two additional posts, making assembly simple and cost-effective.



### Add-on S-hook Model No. TS-ADSH

Use Add-on S-hooks instead of posts to grow your shelving unit. Use two hooks for each Add-on wire shelf and use three hooks for Wide Span shelving.

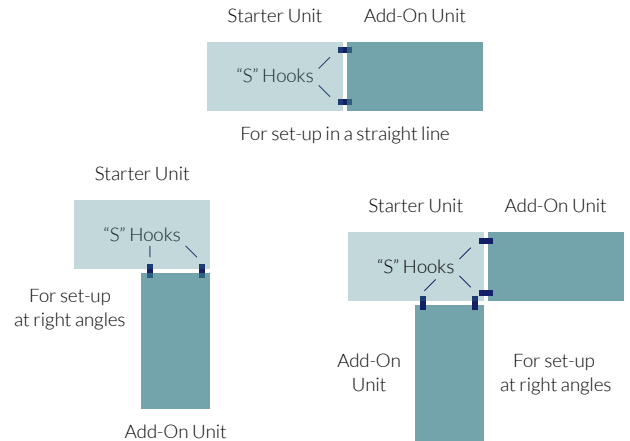

| Size    | 63" High Unit      |                  | 74" High Unit      |                  | 86" High Unit      |                  | Weight           |
|---------|--------------------|------------------|--------------------|------------------|--------------------|------------------|------------------|
| D" x L" | Polyseal Model No. | Chrome Model No. | Polyseal Model No. | Chrome Model No. | Polyseal Model No. | Chrome Model No. | lbs. 63"/74"/86" |
| 14x24   | TS-A14246Z         | TS-A14246C       | TS-A14247Z         | TS-A14247C       | TS-A14248Z         | TS-A14248C       | 38/40/44         |
| 14x30   | TS-A14306Z         | TS-A14306C       | TS-A14307Z         | TS-A14307C       | TS-A14308Z         | TS-A14308C       | 42/44/48         |
| 14x36   | TS-A14366Z         | TS-A14366C       | TS-A14367Z         | TS-A14367C       | TS-A14368Z         | TS-A14368C       | 46/48/52         |
| 14x42   | TS-A14426Z         | TS-A14426C       | TS-A14427Z         | TS-A14427C       | TS-A14428Z         | TS-A14428C       | 52/54/58         |
| 14x48   | TS-A14486Z         | TS-A14486C       | TS-A14487Z         | TS-A14487C       | TS-A14488Z         | TS-A14488C       | 58/60/64         |
| 14x54   | TS-A14546Z         | TS-A14546C       | TS-A14547Z         | TS-A14547C       | TS-A14548Z         | TS-A14548C       | 62/64/68         |
| 14x60   | TS-A14606Z         | TS-A14606C       | TS-A14607Z         | TS-A14607C       | TS-A14608Z         | TS-A14608C       | 72/74/78         |
| 14x66   | TS-A14666Z         | TS-A14666C       | TS-A14667Z         | TS-A14667C       | TS-A14668Z         | TS-A14668C       | 82/84/88         |
| 14x72   | TS-A14726Z         | TS-A14726C       | TS-A14727Z         | TS-A14727C       | TS-A14728Z         | TS-A14728C       | 88/90/94         |
| 18x18   | TS-A18186Z         | TS-A18186C       | TS-A18187Z         | TS-A18187C       | TS-A18188Z         | TS-A18188C       | 40/42/46         |
| 18x24   | TS-A18246Z         | TS-A18246C       | TS-A18247Z         | TS-A18247C       | TS-A18248Z         | TS-A18248C       | 42/44/48         |
| 18x30   | TS-A18306Z         | TS-A18306C       | TS-A18307Z         | TS-A18307C       | TS-A18308Z         | TS-A18308C       | 46/48/52         |
| 18x36   | TS-A18366Z         | TS-A18366C       | TS-A18367Z         | TS-A18367C       | TS-A18368Z         | TS-A18368C       | 52/54/58         |
| 18x42   | TS-A18426Z         | TS-A18426C       | TS-A18427Z         | TS-A18427C       | TS-A18428Z         | TS-A18428C       | 58/60/64         |
| 18x48   | TS-A18486Z         | TS-A18486C       | TS-A18487Z         | TS-A18487C       | TS-A18488Z         | TS-A18488C       | 62/64/68         |
| 18x54   | TS-A18546Z         | TS-A18546C       | TS-A18547Z         | TS-A18547C       | TS-A18548Z         | TS-A18548C       | 72/74/78         |
| 18x60   | TS-A18606Z         | TS-A18606C       | TS-A18607Z         | TS-A18607C       | TS-A18608Z         | TS-A18608C       | 82/84/88         |
| 18x66   | TS-A18666Z         | TS-A18666C       | TS-A18667Z         | TS-A18667C       | TS-A18668Z         | TS-A18668C       | 88/90/94         |
| 18x72   | TS-A18726Z         | TS-A18726C       | TS-A18727Z         | TS-A18727C       | TS-A18728Z         | TS-A18728C       | 94/96/100        |
| 21x24   | TS-A21246Z         | TS-A21246C       | TS-A21247Z         | TS-A21247C       | TS-A21248Z         | TS-A21248C       | 46/48/52         |
| 21x30   | TS-A21306Z         | TS-A21306C       | TS-A21307Z         | TS-A21307C       | TS-A21308Z         | TS-A21308C       | 50/52/56         |
| 21x36   | TS-A21366Z         | TS-A21366C       | TS-A21367Z         | TS-A21367C       | TS-A21368Z         | TS-A21368C       | 58/60/64         |
| 21x42   | TS-A21426Z         | TS-A21426C       | TS-A21427Z         | TS-A21427C       | TS-A21428Z         | TS-A21428C       | 62/64/68         |
| 21x48   | TS-A21486Z         | TS-A21486C       | TS-A21487Z         | TS-A21487C       | TS-A21488Z         | TS-A21488C       | 70/72/76         |
| 21x54   | TS-A21546Z         | TS-A21546C       | TS-A21547Z         | TS-A21547C       | TS-A21548Z         | TS-A21548C       | 78/80/84         |
| 21x60   | TS-A21606Z         | TS-A21606C       | TS-A21607Z         | TS-A21607C       | TS-A21608Z         | TS-A21608C       | 86/88/92         |
| 21x66   | TS-A21666Z         | TS-A21666C       | TS-A21667Z         | TS-A21667C       | TS-A21668Z         | TS-A21668C       | 98/100/104       |
| 21x72   | TS-A21726Z         | TS-A21726C       | TS-A21727Z         | TS-A21727C       | TS-A21728Z         | TS-A21728C       | 110/112/116      |
| 24x24   | TS-A24246Z         | TS-A24246C       | TS-A24247Z         | TS-A24247C       | TS-A24248Z         | TS-A24248C       | 50/52/56         |
| 24x30   | TS-A24306Z         | TS-A24306C       | TS-A24307Z         | TS-A24307C       | TS-A24308Z         | TS-A24308C       | 58/60/64         |
| 24x36   | TS-A24366Z         | TS-A24366C       | TS-A24367Z         | TS-A24367C       | TS-A24368Z         | TS-A24368C       | 66/68/72         |
| 24x42   | TS-A24426Z         | TS-A24426C       | TS-A24427Z         | TS-A24427C       | TS-A24428Z         | TS-A24428C       | 74/76/80         |
| 24x48   | TS-A24486Z         | TS-A24486C       | TS-A24487Z         | TS-A24487C       | TS-A24488Z         | TS-A24488C       | 78/80/84         |
| 24x54   | TS-A24546Z         | TS-A24546C       | TS-A24547Z         | TS-A24547C       | TS-A24548Z         | TS-A24548C       | 90/92/96         |
| 24x60   | TS-A24606Z         | TS-A24606C       | TS-A24607Z         | TS-A24607C       | TS-A24608Z         | TS-A24608C       | 98/100/104       |
| 24x66   | TS-A24666Z         | TS-A24666C       | TS-A24667Z         | TS-A24667C       | TS-A24668Z         | TS-A24668C       | 108/118/124      |
| 24x72   | TS-A24726Z         | TS-A24726C       | TS-A24727Z         | TS-A24727C       | TS-A24728Z         | TS-A24728C       | 118/120/124      |

When placing your order, please be sure to include the -KIT suffix to the model number

## 5-Tier Starter Unit

Maximize storage capacity within standard shelving footprint sizes with our 5-Tier Starter Units. Each unit comprises four numbered posts, five shelves, and plastic clips, providing ample storage space. Easily convert stationary Starter Units into mobile units by adding four polyurethane casters, available in threaded or non-threaded options, for enhanced versatility and convenience.



### Add-on S-hook Model No. TS-ADSH

Use Add-on S-hooks instead of posts to grow your shelving unit. Use two hooks for each Add-on wire shelf and use three hooks for Wide Span shelving.

| Size    | 63" High Unit      |                  | 74" High Unit      |                  | 86" High Unit      |                  | Weight           |
|---------|--------------------|------------------|--------------------|------------------|--------------------|------------------|------------------|
| D" x L" | Polyseal Model No. | Chrome Model No. | Polyseal Model No. | Chrome Model No. | Polyseal Model No. | Chrome Model No. | lbs. 63"/74"/86" |
| 14x36   | TS-14366Z5         | TS-14366C5       | TS-14367Z5         | TS-14367C5       | TS-14368Z5         | TS-14368C5       | 54/56/60         |
| 14x48   | TS-14486Z5         | TS-14486C5       | TS-14487Z5         | TS-14487C5       | TS-14488Z5         | TS-14488C5       | 68/70/74         |
| 14x60   | TS-14606Z5         | TS-14606C5       | TS-14607Z5         | TS-14607C5       | TS-14608Z5         | TS-14608C5       | 86/88/92         |
| 18x36   | TS-18366Z5         | TS-18366C5       | TS-18367Z5         | TS-18367C5       | TS-18368Z5         | TS-18368C5       | 62/64/68         |
| 18x48   | TS-18486Z5         | TS-18486C5       | TS-18487Z5         | TS-18487C5       | TS-18488Z5         | TS-18488C5       | 74/76/80         |
| 18x60   | TS-18606Z5         | TS-18606C5       | TS-18607Z5         | TS-18607C5       | TS-18608Z5         | TS-18608C5       | 99/101/105       |
| 21x36   | TS-21366Z5         | TS-21366C5       | TS-21367Z5         | TS-21367C5       | TS-21368Z5         | TS-21368C5       | 69/71/75         |
| 21x48   | TS-21486Z5         | TS-21486C5       | TS-21487Z5         | TS-21487C5       | TS-21488Z5         | TS-21488C5       | 84/86/90         |
| 21x60   | TS-21606Z5         | TS-21606C5       | TS-21607Z5         | TS-21607C5       | TS-21608Z5         | TS-21608C5       | 104/106/110      |
| 24x36   | TS-24366Z5         | TS-24366C5       | TS-24367Z5         | TS-24367C5       | TS-24368Z5         | TS-24368C5       | 79/81/85         |
| 24x48   | TS-24486Z5         | TS-24486C5       | TS-24487Z5         | TS-24487C5       | TS-24488Z5         | TS-24488C5       | 94/96/100        |
| 24x60   | TS-24606Z5         | TS-24606C5       | TS-24607Z5         | TS-24607C5       | TS-24608Z5         | TS-24608C5       | 119/121/125      |

Order casters separately

## Shelf Overlays/Inlays

Shelf Overlays/Inlays are the perfect solution for areas where spillage is a concern. Additionally, they are ideal for use on bottom shelves to prevent dust accumulation, ensuring cleanliness and ease of maintenance.

| Size D" x L" | Stainless steel Model No. | Polypropylene Model No. |
|--------------|---------------------------|-------------------------|
| 18x36        | TS-OL1836S                | TS-SI1836               |
| 18x48        | TS-OL1848S                | TS-SI1848               |
| 18x60        | TS-OL1860S                | TS-SI1860               |
| 24x36        | TS-OL2436S                | TS-SI2436               |
| 24x48        | TS-OL2448S                | TS-SI2448               |
| 24x60        | TS-OL2460S                | TS-SI2460               |
| 30x60        | TS-OL3060S                | TS-SI3060               |

Custom sizes available. Shelves sold separately



## 4-Tier Starter Unit with Dunnage Base

Designed to tackle heavy loads with ease, our Dunnage Shelving provides a robust solution for organizing your heaviest items. Each unit comes complete with four numbered posts, three standard wire shelves, a square tube dunnage shelf, and plastic clips, offering both strength and versatility. Choose the configuration that suits your needs - order with or without a dunnage mat. Whether in warehouses, industrial settings, or commercial kitchens, this versatile shelving system ensures stability and durability, keeping your space organized and efficient.

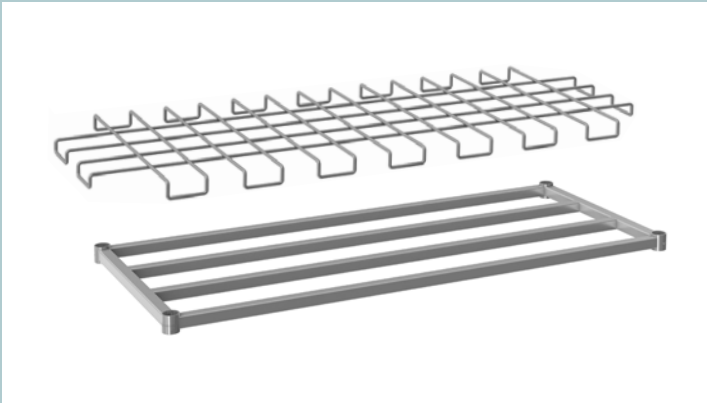

**Dunnage Shelf and Mat can be added to any unit see page 10 for more information.**

**When placing your order, please be sure to include the -KIT suffix to the model number.**

| Size   | 63" High Unit      |                  | 74" High Unit      |                  | Weight       |
|--|--------------------|------------------|--------------------|------------------|--------------|
| D" x L"  | Polyseal Model No. | Chrome Model No. | Polyseal Model No. | Chrome Model No. | lbs. 63"/74" |
| <b>4-Tier Starter Unit with bottom Dunnage Shelf with Mat</b>    |                    |                  |                    |                  |              |
| 14x36  | TS-14366ZDM        | TS-14366CDM      | TS-14367ZDM        | TS-14367CDM      | 50/52        |
| 14x48  | TS-14486ZDM        | TS-14486CDM      | TS-14487ZDM        | TS-14487CDM      | 62/64        |
| 14x60  | TS-14606ZDM        | TS-14606CDM      | TS-14607ZDM        | TS-14607CDM      | 76/78        |
| 18x36  | TS-18366ZDM        | TS-18366CDM      | TS-18367ZDM        | TS-18367CDM      | 57/60        |
| 18x48  | TS-18486ZDM        | TS-18486CDM      | TS-18487ZDM        | TS-18487CDM      | 67/70        |
| 18x60  | TS-18606ZDM        | TS-18606CDM      | TS-18607ZDM        | TS-18607CDM      | 87/90        |
| 21x36  | TS-21366ZDM        | TS-21366CDM      | TS-21367ZDM        | TS-21367CDM      | 64/66        |
| 21x48  | TS-21486ZDM        | TS-21486CDM      | TS-21487ZDM        | TS-21487CDM      | 76/78        |
| 21x60  | TS-21606ZDM        | TS-21606CDM      | TS-21607ZDM        | TS-21607CDM      | 92/94        |
| 24x36  | TS-24366ZDM        | TS-24366CDM      | TS-24367ZDM        | TS-24367CDM      | 74/76        |
| 24x48  | TS-24486ZDM        | TS-24486CDM      | TS-24487ZDM        | TS-24487CDM      | 86/88        |
| 24x60  | TS-24606ZDM        | TS-24606CDM      | TS-24607ZDM        | TS-24607CDM      | 106/108      |
| <b>4-Tier Starter Unit with bottom Dunnage Shelf without Mat</b> |                    |                  |                    |                  |              |
| 14x36  | TS-14366ZD         | TS-14366CD       | TS-14367ZD         | TS-14367CD       | 48/50        |
| 14x48  | TS-14486ZD         | TS-14486CD       | TS-14487ZD         | TS-14487CD       | 60/62        |
| 14x60  | TS-14606ZD         | TS-14606CD       | TS-14607ZD         | TS-14607CD       | 74/76        |
| 18x36  | TS-18366ZD         | TS-18366CD       | TS-18367ZD         | TS-18367CD       | 55/58        |
| 18x48  | TS-18486ZD         | TS-18486CD       | TS-18487ZD         | TS-18487CD       | 65/68        |
| 18x60  | TS-18606ZD         | TS-18606CD       | TS-18607ZD         | TS-18607CD       | 85/88        |
| 21x36  | TS-21366ZD         | TS-21366CD       | TS-21367ZD         | TS-21367CD       | 61/63        |
| 21x48  | TS-21486ZD         | TS-21486CD       | TS-21487ZD         | TS-21487CD       | 73/75        |
| 21x60  | TS-21606ZD         | TS-21606CD       | TS-21607ZD         | TS-21607CD       | 89/91        |
| 24x36  | TS-24366ZD         | TS-24366CD       | TS-24367ZD         | TS-24367CD       | 71/73        |
| 24x48  | TS-24486ZD         | TS-24486CD       | TS-24487ZD         | TS-24487CD       | 83/85        |
| 24x60  | TS-24606ZD         | TS-24606CD       | TS-24607ZD         | TS-24607CD       | 103/105      |

**Order Casters separately**





# Racks & Carts

## Beer Keg Rack

Stat Medical's Beer Keg Rack is designed to save time and space while serving as a robust storage solution.

Featuring four numbered posts for swift assembly, it boasts two 1500 lb. capacity Channel Dunnage Shelves, ensuring sturdy support for heavy loads. Additionally, two 3-sided frames enhance stability, promising reliable storage for your beverage inventory.

| Size D" x L" x H" | Polyseal Model No. | Weight lbs. |
|-------------------|--------------------|-------------|
| 18 x 36 x 54      | TS-KR18365Z-KIT    | 48          |
| 18 x 48 x 54      | TS-KR18485Z-KIT    | 58          |
| 18 x 60 x 54      | TS-KR18605Z-KIT    | 68          |
| 18 x 36 x 63      | TS-KR18366Z        | 49          |
| 18 x 48 x 63      | TS-KR18486Z        | 59          |
| 18 x 60 x 63      | TS-KR18606Z        | 69          |

Additional sizes available.



## Utility Rack

Engineered to meet heavy storage demands, our Utility Rack offers versatility and strength.

Featuring four numbered posts for easy assembly, it includes two 1500 lb. capacity Channel Dunnage Shelves for robust support. Additionally, two Dunnage Shelf Mats provide added stability, while two 3-Sided Frames ensure reinforced strength.

Experience the convenience and reliability of our Utility Rack, tailored to meet diverse storage needs effortlessly.

| Size D" x L" x H" | Polyseal Model No. | Weight lbs. |
|-------------------|--------------------|-------------|
| 18 x 36 x 54      | TS-CR18365Z-KIT    | 62          |
| 18 x 48 x 54      | TS-CR18485Z-KIT    | 76          |
| 18 x 60 x 54      | TS-CR18605Z-KIT    | 96          |
| 18 x 36 x 63      | TS-CR18366Z-KIT    | 63          |
| 18 x 48 x 63      | TS-CR18486Z-KIT    | 77          |
| 18 x 60 x 63      | TS-CR18606Z-KIT    | 97          |

Additional sizes available.



# Racks & Carts

## Channel Dunnage Rack

Stat Medical's Channel Dunnage Rack is a robust and adaptable low-profile solution, designed to meet your heavy duty storage needs. With a load capacity of 1500 lbs., this Polyseal rack includes four posts, one heavy duty Channel Dunnage Shelf, and a 3-sided frame for added stability. Experience strength and versatility with our Channel Dunnage Rack, ideal for a variety of storage applications.

60 inch channel dunnage racks include 1 centre support rod.



| Size<br>D" x L" x H" | Rack<br>Without Mat | Rack<br>With Mat | Weight<br>lbs. |
|----------------------|---------------------|------------------|----------------|
| 18x24x14             | TS-DR1824Z-KIT      | TS-DRM1824Z-KIT  | 14/26          |
| 18x30x14             | TS-DR1830Z-KIT      | TS-DRM1830Z-KIT  | 18/28          |
| 18x36x14             | TS-DR1836Z-KIT      | TS-DRM1836Z-KIT  | 22/32          |
| 18x48x14             | TS-DR1848Z-KIT      | TS-DRM1848Z-KIT  | 26/40          |
| 18x60x14             | TS-DR1860Z-KIT      | TS-DRM1860Z-KIT  | 33/47          |
| 24x24x14             | TS-DR2424Z-KIT      | TS-DRM2424Z-KIT  | 16/27          |
| 24x30x14             | TS-DR2430Z-KIT      | TS-DRM2430Z-KIT  | 20/29          |
| 24x36x14             | TS-DR2436Z-KIT      | TS-DRM2436Z-KIT  | 24/34          |
| 24x48x14             | TS-DR2448Z-KIT      | TS-DRM2448Z-KIT  | 28/41          |
| 24x60x14             | TS-DR2460Z-KIT      | TS-DRM2460Z-KIT  | 36/49          |

| Dunnage Rack Centre Support         |  |  |   |
|-------------------------------------|--|--|---|
| 14" Polyseal Centre Support P14ZSTS |  |  | 2 |

Available with or without shelf mat. Additional sizes available

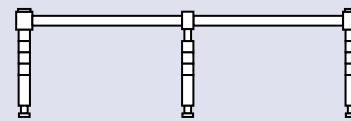

Dunnage Rack Centre Support for additional support on long spans



TS-P14ZSTS

## Mobile Channel Dunnage Rack

Experience mobility without sacrificing strength with our Mobile Channel Dunnage Rack. With a mobile load rating of up to 1200 lbs., this rack features four Polyseal posts, one heavy duty Polyseal Channel Dunnage Shelf, and a 3-sided Polyseal frame for added stability.

Additionally, equipped with four 5" polyurethane swivel casters, two with brakes, this rack offers flexibility and convenience for your storage needs.

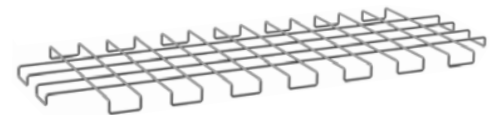

Dunnage Shelf Mat can be added to any unit see page 10 for more information.

| Size<br>D" x L" x H" | Rack<br>Without Mat | Rack<br>With Mat | Weight<br>lbs. |
|----------------------|---------------------|------------------|----------------|
| 18x24x12             | TS-DM1824Z-KIT      | TS-DMM1824Z-KIT  | 24/36          |
| 18x30x12             | TS-DM1830Z-KIT      | TS-DMM1830Z-KIT  | 28/38          |
| 18x36x12             | TS-DM1836Z-KIT      | TS-DMM1836Z-KIT  | 32/42          |
| 18x48x12             | TS-DM1848Z-KIT      | TS-DMM1848Z-KIT  | 36/50          |
| 18x60x12             | TS-DM1860Z-KIT      | TS-DMM1860Z-KIT  | 43/57          |
| 24x24x12             | TS-DM2424Z-KIT      | TS-DMM2424Z-KIT  | 26/37          |
| 24x30x12             | TS-DM2430Z-KIT      | TS-DMM2430Z-KIT  | 30/39          |
| 24x36x12             | TS-DM2436Z-KIT      | TS-DMM2436Z-KIT  | 34/44          |
| 24x48x12             | TS-DM2448Z-KIT      | TS-DMM2448Z-KIT  | 38/51          |
| 24x60x12             | TS-DM2460Z-KIT      | TS-DMM2460Z-KIT  | 46/59          |

Available with or without shelf mat. Additional sizes available



# Racks & Carts

## Wire Platform

Complete with four posts and one shelf, along with plastic clips and adjustable levelers, this platform is designed to optimize your space. Ideal for getting products off the floor to meet health and hygiene codes, it offers a versatile and practical storage solution for various settings.

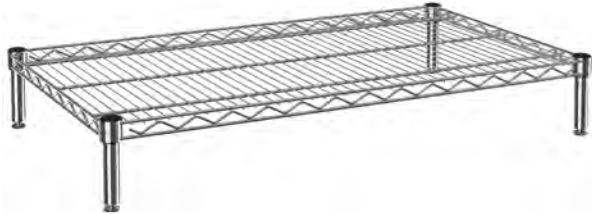

| Size D" x L" x H" | Polyseal Model No. | Chrome Model No. | Weight lbs. |
|-------------------|--------------------|------------------|-------------|
| 18x24x6           | TS-P1824Z          | TS-P1824C-KIT    | 9           |
| 18x30x6           | TS-P1830Z-KIT      | TS-P1830C-KIT    | 10          |
| 18x36x6           | TS-P1836Z-KIT      | TS-P1836C-KIT    | 12          |
| 21x24x6           | TS-P2124Z-KIT      | TS-P2124C-KIT    | 10          |
| 21x30x6           | TS-P2130Z-KIT      | TS-P2130C-KIT    | 11          |
| 21x36x6           | TS-P2136Z-KIT      | TS-P2136C-KIT    | 13          |
| 24x24x6           | TS-P2424Z-KIT      | TS-P2424C-KIT    | 11          |
| 24x30x6           | TS-P2430Z-KIT      | TS-P2430C-KIT    | 13          |
| 24x36x6           | TS-P2436Z-KIT      | TS-P2436C-KIT    | 15          |

**Additional sizes available**

## Light Duty Display Rack

Perfect for showcasing bread, confectionary, and lightweight grocery items, the black coating ensures maximum visual impact. Each rack includes four 14" posts with adjustable levelers, one shelf, and shelf clips for easy setup. Additional sizes are available for added versatility.

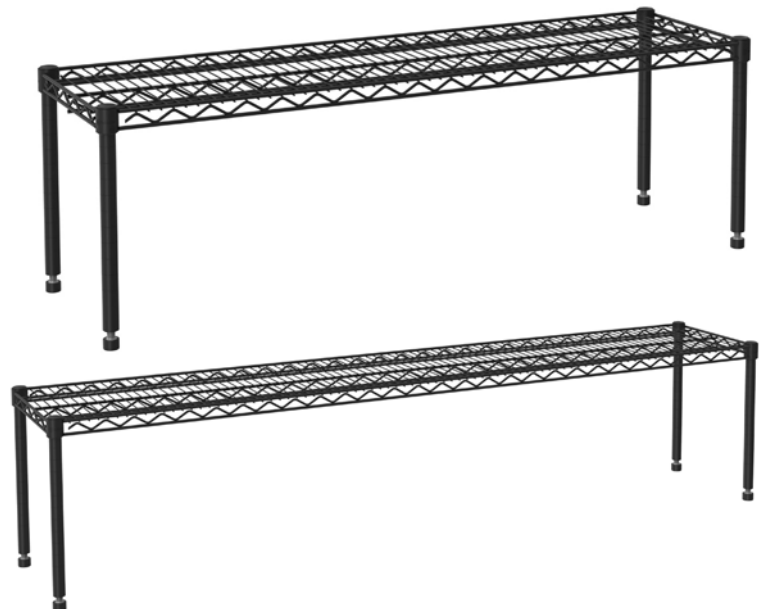

| Size D" x L" x H" | Model No.        | Weight lbs. |
|-------------------|------------------|-------------|
| 14x24x14          | TS-SBR1424EB-KIT | 9           |
| 14x36x14          | TS-SBR1436EB-KIT | 12          |
| 14x48x14          | TS-SBR1448EB-KIT | 15          |
| 14x60x14          | TS-SBR1460EB-KIT | 18          |
| 14x72x14          | TS-SBR1472EB-KIT | 21          |

## Aluminum Milk Crate & Glass Rack Dolly

Crafted with aluminum frame construction, this dolly boasts a lightweight yet durable design. Equipped with heavy-duty 5" swivel casters, it offers effortless mobility for transporting and storage needs. Perfect for various applications, this dolly is your ideal solution for efficient and convenient handling of milk crates, glass racks, and more!



| Size D" x L" x H" | Model No.       | Weight lbs. |
|-------------------|-----------------|-------------|
| 14x14x8           | TF-DD1414A-KIT  | 12          |
| 20x20x8           | TF-GRD2020A-KIT | 15          |

**Contact us for custom dollies.**

# Racks & Carts

## Beverage Rack

Beverage Rack dividers effortlessly clip onto Stat Medical shelving, simplifying bottle and can storage.

Each rack comes complete with four posts featuring levelers and numbered for quick setup, two standard Stat Medical shelves, two Flex Mount Shelves (shown as a slanted installation), two bottle/can dividers with a Polyseal finish, and one 3-sided frame for added stability. Additional dividers are also available for separate purchase.



| Size<br>D" x L" x H"                | Polyseal<br>Model No. | Chrome<br>Model No. | Weight<br>lbs. |
|-------------------------------------|-----------------------|---------------------|----------------|
| 24x48x63                            | TS-BCRU2448Z-KIT      | TS-BCRU2448C-KIT    | 84             |
| 24x60x63                            | TS-BCRU2460Z-KIT      | TS-BCRU2460C-KIT    | 106            |
| Additional Bottle/Can Rack Dividers |                       |                     |                |
| 24x48                               | TS-BCR2448Z-KIT       | N/A                 | 2              |
| 24x60                               | TS-BCR2460Z-KIT       | N/A                 | 3              |

See page 7 for additional Flex Mount Shelves.

## Can Racks and Dispensers

Stat Medical's Can Racks and Dispensers offer easy access and storage for canned goods. The 24" dispenser holds eight #10 cans, while the 18" dispenser holds six. The complete Can Rack Unit includes four posts with levelers, four shelves, and nine can dispensers.

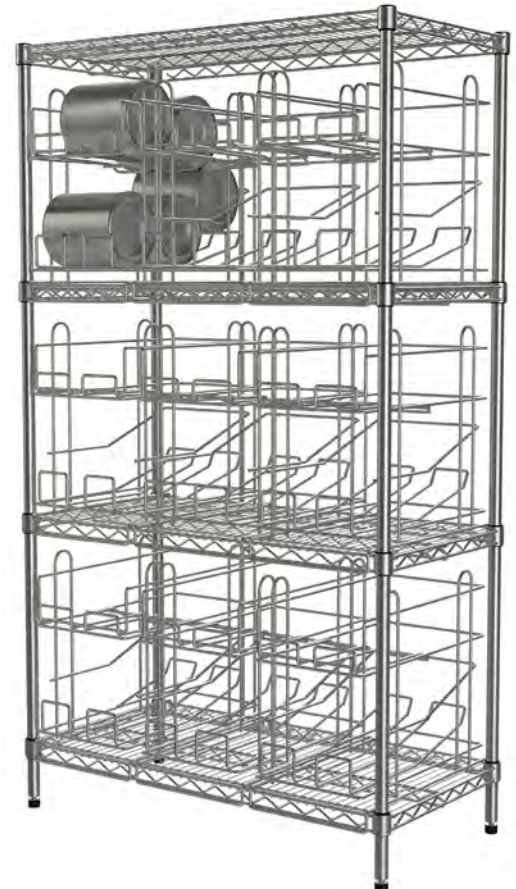

| Size<br>D" x L" x H"      | Polyseal<br>Model No. | Weight<br>lbs. |
|---------------------------|-----------------------|----------------|
| 18x36x63                  | TS-CRU1836Z-KIT       | 86             |
| 24x36x63                  | TS-CRU2436Z-KIT       | 111            |
| Additional Can Dispensers |                       |                |
| 18.5x10x15                | TS-CR18Z              | 3              |
| 24.5x10x15                | TS-CR24Z              | 4              |

# Racks & Carts

## Mail Room Delivery Cart

Ideal for transporting office documents, the Mail Room Delivery Cart comes in single basket and double basket styles. The single basket style includes one basket shelf, one traditional shelf, two utility cart handles, one pair of file folder dividers, and two stem swivel and two stem brake casters.

The double basket style features two basket shelves, four 34" posts, two safety push handles, one pair of file folder dividers, two stem swivel, two stem brake casters, and four donut bumpers. Both styles have a maximum load capacity of 100 pounds in the basket shelf.

| Size<br>D" x L" x H"                   | Chrome<br>Model No. | Weight<br>lbs. |
|--|---------------------|----------------|
| 18x36x38                               | TS-MDC1836C-1       | 29             |
| 18x36x38                               | TS-MDC1836C-2       | 40             |
| <b>Additional Basket Shelves</b>       |                     |                |
| 18x36                                  | TS-BS1836C          | 8              |
| <b>Additional File Folder Dividers</b> |                     |                |
| 18                                     | TS-FFD18C           | 1              |



TS-BS1836C



TS-MDC1836C-1



TS-MDC1836C-2

## All Purpose Sorting Rack

Perfect for sorting incoming mail, faxes, and other documents, our standard 15-compartment design offers efficiency and organization.

Custom sizes and styles are available upon request. Each unit comes complete with four shelves, four posts, twelve 4" dividers, and four non-marking levelers.

| Size<br>D" x L" x H"       | Polyseal<br>Model No. | Weight<br>lbs. |
|----------------------------|-----------------------|----------------|
| 18x48x28                   | TS-MRSR1448C          | 65             |
| <b>Additional Dividers</b> |                       |                |
| 14x4                       | TS-SD414C             | 2              |

Can be used in a mailroom, employee cubbies, divider rack, merchandiser, etc.

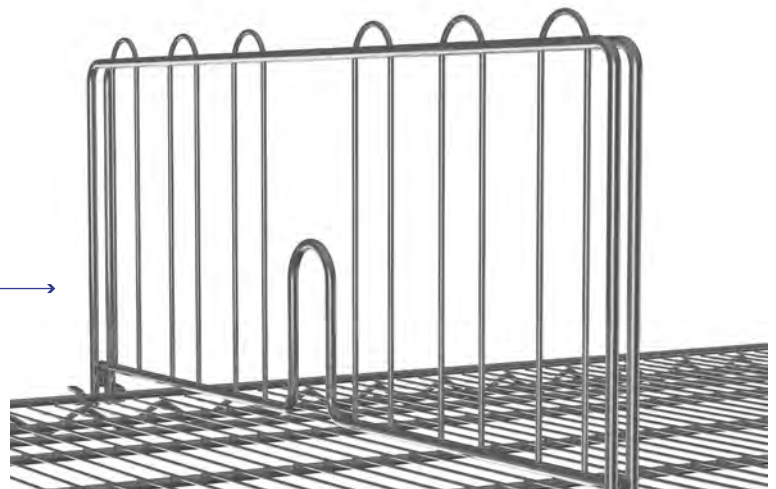
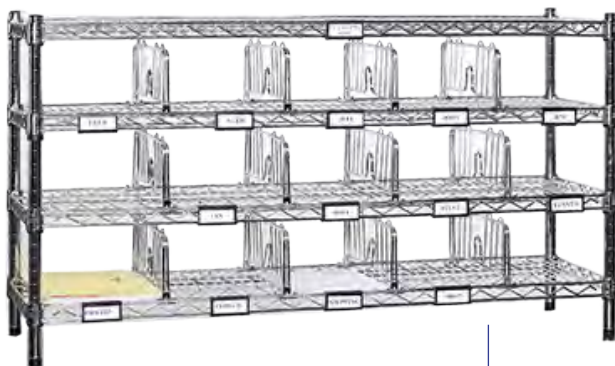

# Racks & Carts

## Utility Cart

Streamline the transport of small packages with our Utility Cart. This versatile solution comes complete with a choice of two or three shelves in Polyseal or Chrome, four 5" heavy-duty swivel casters (two with brakes), and two U-shaped chrome handles. With a mobile load capacity of up to 1200 lbs. and an overall height of 38", it offers both strength and maneuverability. Utility Carts are also available with Solid Stainless Steel Shelves as an option, providing versatility to meet specific application requirements.



### Utility Cart Handle

Designed for the utility cart, the 33" high handle available in chrome only is constructed of 1" tubing grooved at 1" increments.

| Size D" | Model No. | Wt lbs. |
|---------|-----------|---------|
| 14      | TS-UCH14C | 2       |
| 18      | TS-UCH18C | 2       |
| 21      | TS-UCH21C | 3       |
| 24      | TS-UCH24C | 4       |



TS-UC18362C



TS-UC18303C

| Size D" x L" | 2-Tier Unit        |                  |             | 3-Tier Unit        |                  |             |
|--------------|--------------------|------------------|-------------|--------------------|------------------|-------------|
|              | Polyseal Model No. | Chrome Model No. | Weight lbs. | Polyseal Model No. | Chrome Model No. | Weight lbs. |
| 14x30        | TS-UC14302Z-KIT    | TS-UC14302C-KIT  | 39          | TS-UC14303Z-KIT    | TS-UC14303C-KIT  | 47          |
| 14x36        | TS-UC14362Z-KIT    | TS-UC14362C-KIT  | 42          | TS-UC14363Z-KIT    | TS-UC14363C-KIT  | 52          |
| 14x42        | TS-UC14422Z-KIT    | TS-UC14422C-KIT  | 43          | TS-UC14423Z-KIT    | TS-UC14423C-KIT  | 53          |
| 14x48        | TS-UC14482Z-KIT    | TS-UC14482C-KIT  | 45          | TS-UC14483Z-KIT    | TS-UC14483C-KIT  | 55          |
| 18x30        | TS-UC18302Z-KIT    | TS-UC18302C-KIT  | 39          | TS-UC18303Z-KIT    | TS-UC18303C-KIT  | 47          |
| 18x36        | TS-UC18362Z-KIT    | TS-UC18362C-KIT  | 42          | TS-UC18363Z-KIT    | TS-UC18363C-KIT  | 52          |
| 18x42        | TS-UC18422Z-KIT    | TS-UC18422C-KIT  | 45          | TS-UC18423Z-KIT    | TS-UC18423C-KIT  | 56          |
| 18x48        | TS-UC18482Z-KIT    | TS-UC18482C-KIT  | 49          | TS-UC18483Z-KIT    | TS-UC18483C-KIT  | 61          |
| 21x30        | TS-UC21302Z-KIT    | TS-UC21302C-KIT  | 41          | TS-UC21303Z-KIT    | TS-UC21303C-KIT  | 50          |
| 21x36        | TS-UC21362Z-KIT    | TS-UC21362C-KIT  | 45          | TS-UC21363Z-KIT    | TS-UC21363C-KIT  | 56          |
| 21x42        | TS-UC21422Z-KIT    | TS-UC21422C-KIT  | 47          | TS-UC21423Z-KIT    | TS-UC21423C-KIT  | 59          |
| 21x48        | TS-UC21482Z-KIT    | TS-UC21482C-KIT  | 51          | TS-UC21483Z-KIT    | TS-UC21483C-KIT  | 65          |
| 24x30        | TS-UC24302Z-KIT    | TS-UC24302C-KIT  | 46          | TS-UC24303Z-KIT    | TS-UC24303C-KIT  | 57          |
| 24x36        | TS-UC24362Z-KIT    | TS-UC24362C-KIT  | 50          | TS-UC24363Z-KIT    | TS-UC24363C-KIT  | 63          |
| 24x42        | TS-UC24422Z-KIT    | TS-UC24422C-KIT  | 54          | TS-UC24423Z-KIT    | TS-UC24423C-KIT  | 69          |
| 24x48        | TS-UC24482Z-KIT    | TS-UC24482C-KIT  | 56          | TS-UC24483Z-KIT    | TS-UC24483C-KIT  | 72          |
| 24x60        | TS-UC24602Z-KIT    | TS-UC24602C-KIT  | 66          | TS-UC24603Z-KIT    | TS-UC24603C-KIT  | 87          |

# Racks & Carts

## Universal Bun Pan & Insert Pan Rack

This mobile shelving unit boasts a 36-pan capacity and features independently adjustable sections to accommodate 12" x 20" pans as well as all sizes of pizza and bun pans.

Complete with four posts, numbered for quick set-up, and four 5" swivel casters (2 with brakes), this rack ensures ease of mobility and stability. The 60" unit includes three shelves, while the 80" unit offers four shelves. Tray slides with 1½" spacing provide efficient organization and accessibility.

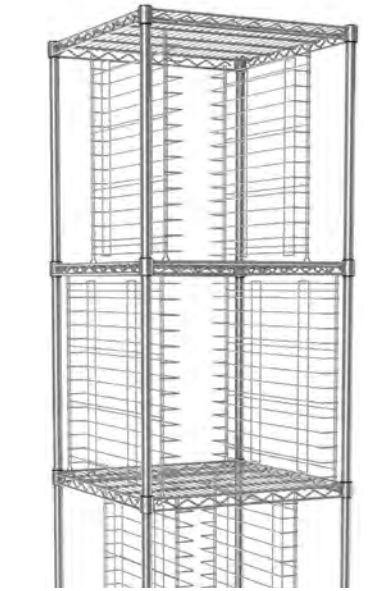
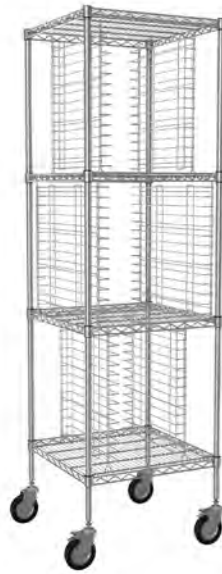

| Size<br>D" x L" x H" | PolySeal<br>Model No. | Sets of Tray<br>Slides |
|----------------------|-----------------------|------------------------|
| 24x24x60             | TS-UPR242460Z-KIT     | 2                      |
| 24x24x80             | TS-UPR242480Z-KIT     | 3                      |

## Stainless Steel Knock Down Bun Pan Rack

Built for durability, this rack features heavy-duty stainless steel construction with 1" square tube uprights and cross braces, along with 1.5" angle slides.

Equipped with 5" swivel casters with brakes, it offers mobility and stability. With a 40 pan capacity on 1.5" spacing, 20 pan capacity on 3" spacing, and 12 pan capacity on 5" spacing, it provides versatile storage options.

Enhance durability with fully welded assembly by including TF-FWPRE in your order.



| Description | Stainless<br>Model No. | Pan<br>Capacity | Shelf<br>Spacing | Overall Size<br>D"xL"xH" | Weight<br>lbs. |
|-------------|------------------------|-----------------|------------------|--------------------------|----------------|
| End Load    | TS-PRE15S              | 40              | 1.5"             | 27x19x70                 | 55             |
| End Load    | TS-PRE30S              | 20              | 3"               | 27x19x70                 | 45             |
| End Load    | TS-PRE50S              | 12              | 5"               | 27x19x70                 | 40             |

## Tray Slide Inserts

Tray Slide Inserts feature a flexible design that accommodates any size pan or tray with ease. With 1.5" slide spacing, each insert holds one tray per slide, ensuring efficient organization and accessibility for your kitchen or storage area.

| Size<br>D" x H" | Description                | Polyseal<br>Model No. | Weight<br>lbs. |
|-----------------|----------------------------|-----------------------|----------------|
| 18x22           | 18" Deep Tray Slide        | TS-TS18Z              | 10             |
| 24x22           | 24" Deep Tray Slide        | TS-TS24Z              | 12             |
| 24x4            | 24" Deep Single Tray Slide | TS-ST524Z             | 2              |

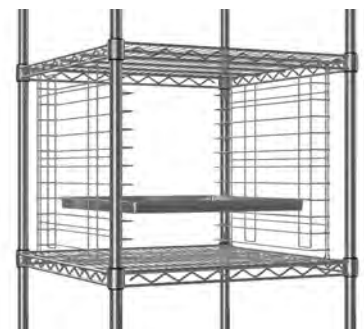
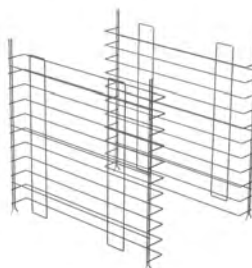

# Racks & Carts

## Linen Cart

Designed for functionality, the Linen Cart features three shelves, side and back enclosures, and four 5" heavy-duty polyurethane swivel casters (two with brakes).

Its open wire shelves promote air circulation and enhance visibility while minimizing moisture and dust accumulation. With a mobile load capacity of up to 1200 lbs., it ensures reliable mobility and storage. Additional shelves are also available for added customization.



| Size D" x L" x H"  | Chrome Model No. | Weight lbs. |
|--------------------|------------------|-------------|
| 24x24x69           | TS-LC2436C-KIT   | 81          |
| 24x48x69           | TS-LC2448C-KIT   | 90          |
| 24x60x69           | TS-LC2460CKIT    | 105         |
| Additional Shelves |                  |             |
| 24x36              | TS-S2436C        | 13          |
| 24x48              | TS-S2448C        | 16          |
| 24x60              | TS-S2460C        | 21          |

## Apparel Cart

Tailored for efficient compartmentalized linen delivery, the Apparel Cart provides space for both hanging and folded linens, making it ideal for laundry delivery to multiple rooms or locations. Available in your choice of 12 or 35 compartment designs, each cart includes label holders for easy organization. Equipped with 5" polyurethane non-marking casters, two with brakes, and donut bumpers, it ensures smooth mobility and protection. For heavy-duty use or multiple floor surface applications, consider adding the optional dolly base (See page 26).

| Size D" x L" x H"  | Chrome Model No. | Weight lbs. |
|--|------------------|-------------|
| 24x60x69   | TS-AC246012C-KIT | 120         |
| 24x60x69   | TS-AC246035C-KIT | 120         |
| Assembly recommended but not required.<br>If ordering assembled, add TS-ASSEMBLY to your order |                  |             |
| Additional 6 Collar Shelves  |                  |             |
| 24x60  | TS-S2460C6C      | 20          |

Looking for a custom design? We're here to bring your vision to life. Give us a call today!





# Racks & Carts

## Linen Collection Cart

Effortless linen collection is made simple with our open-frame top design. Enclosed on all four sides with a wire shelf bottom, it ensures secure containment. Complete with four 5" swivel casters (two with brakes), it offers smooth mobility and stability. Additional sizes, including taller units for empty box collection, are also available.



| Size D" x L" x H" | Chrome Model No. | Weight lbs. |
|-------------------|------------------|-------------|
| 24x24x40          | TS-LDC2424C-KIT  | 45          |

## Garment Rack

Efficiently store and transport garments with the Garment Rack. The open wire design promotes airflow for freshness.

Each unit includes two shelves adjustable at 1" increments, four posts, and four 5" casters (two with brakes) with four donut bumpers for stability. Additionally, it features a hanger rod and two rod hooks for added convenience.

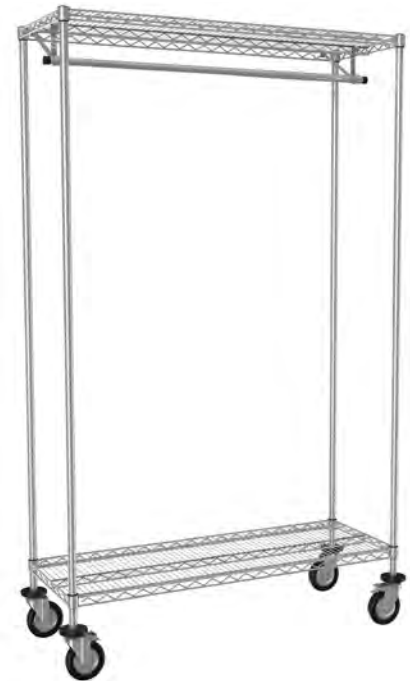

| Size D" x L" x H" | Chrome Model No. | Weight lbs. |
|-------------------|------------------|-------------|
| 18x36x74          | TS-GS1836C-KIT   | 48          |
| 18x48x74          | TS-GS1848C-KIT   | 55          |
| 18x60x74          | TS-GS1860C-KIT   | 70          |
| 18x72x74          | TS-GS1872C-KIT   | 75          |

Contact us for additional sizes.

## Wall Garment Storage

This single shelf unit easily attaches to the wall, offering a practical storage solution.

Each unit includes one shelf, two Single Wall Mount Brackets, a hanger rod, and two rod hooks for versatile storage options.



| Size D" x L" | Chrome Model No. | Weight lbs. |
|--------------|------------------|-------------|
| 24x36        | TS-GWS2436C-KIT  | 18          |
| 24x48        | TS-GWS2448C-KIT  | 21          |
| 24x60        | TS-GWS2460C-KIT  | 26          |

# Storage & Security

## Stationary & Mobile Security Units

Stat Medical Security Units provide a secure and reliable solution for storing valuable equipment and inventory. With lockable doors and durable materials, they offer enhanced security and long-lasting reliability.

Featuring a two-inch square open mesh grid for high visibility, these units include lockable double doors that open a full 270° to keep contents protected.

Easily assembled, each unit comes complete with four shelves with plastic clips, four numbered posts for quick setup, and back, side, and front door panels. Stationary units stand 63" high, while mobile units stand 69" high.

| Size W" x L" | Stationary Polyseal Model No. | Mobile Polyseal Model No. | Weight lbs. |
|--------------|-------------------------------|---------------------------|-------------|
| 18x36        | TS-SU1836Z-KIT                | TS-MSU1836Z-KIT           | 124/134     |
| 18x48        | TS-SU1848Z-KIT                | TS-MSU1848Z-KIT           | 145/155     |
| 24x36        | TS-SU2436Z-KIT                | TS-MSU2436Z-KIT           | 132/142     |
| 24x48        | TS-SU2448Z-KIT                | TS-MSU2448Z-KIT           | 155/165     |
| 24x60        | TS-SU2460Z-KIT                | TS-MSU2460Z-KIT           | 175/185     |

### Additional Shelves

| Size W"xL" | Polyseal Model No. | Weight lbs. |
|------------|--------------------|-------------|
| 18x36      | TS-S1836Z          | 9           |
| 18x48      | TS-S1848Z          | 12          |
| 24x36      | TS-S2436Z          | 13          |
| 24x48      | TS-S2448Z          | 16          |
| 24x60      | TS-S2460Z          | 21          |



To receive the recommended assembled base, add **TS-ASSEMBLY** to your order.

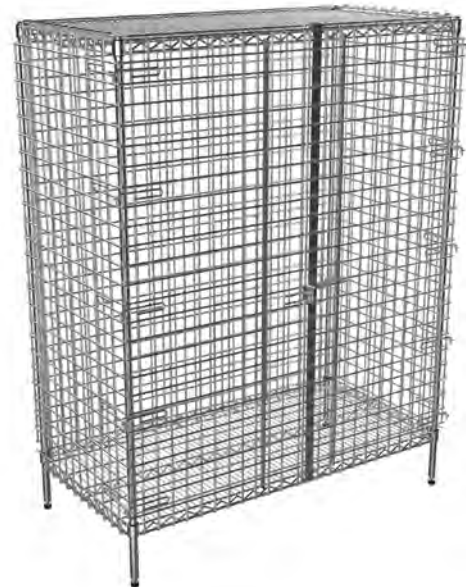

## Dolly Base

The heavy duty metal Dolly Base is the ideal choice for high-volume transport or when dealing with multiple varying floor surfaces.

| Size W" x L" | Chrome Model No. | Weight lbs. |
|--------------|------------------|-------------|
| 18x36        | TS-DBC1836       | 18          |
| 18x48        | TS-DBC1848       | 20          |
| 18x60        | TS-DBC1860       | 22          |
| 24x36        | TS-DBC2436       | 22          |
| 24x48        | TS-DBC2448       | 24          |
| 24x60        | TS-DBC2460       | 26          |
| 24x72        | TS-DBC2472       | 28          |
| 30x36        | TS-DBC3036       | 26          |
| 30x48        | TS-DBC3048       | 28          |
| 30x60        | TS-DBC3060       | 30          |



Casters sold separately

# Storage & Security

## Lockers

Constructed from heavy-duty 16 gauge steel with a durable painted grey finish, these lockers provide a reliable storage solution. They accept standard padlocks and feature adjustable legs. Available in four popular configurations, these lockers are shipped assembled for ease of use. Locks not included.

## Wire Lockers

With six compartments hinged on the right and constructed from wire, these lockers offer ventilation to reduce odours while securely storing contents. The compartments ensure visibility for health and safety and are finished with Polyseal for durability and corrosion resistance.



TS-L12602P



TS-L12605P



TS-WL121578

| Overall Size D" x L" x H" | Description               | Model No.   | Weight lbs. |
|---------------------------|---------------------------|-------------|-------------|
| 15x12x67                  | 1 Compartment             | TS-L12601P  | 30          |
| 15x12x79                  | 2 Compartment             | TS-L12602P  | 35          |
| 15x12x67                  | 5 Compartment             | TS-L12605P  | 30          |
| 15x12x79                  | 6 Compartment             | TS-L12606P  | 35          |
| 15x12x78                  | 6 Compartment Wire Locker | TS-WL121578 | 30          |

**Height includes 6" legs**

# Retail Solutions

## Bulk Wine Bottle Storage

Providing a secure solution for storing large quantities of wine bottles, these units feature an open wire design for easy visibility and temperature control. With three sides enclosed to reduce breakage, these units are versatile in accommodating different storage needs.

The 63" high unit includes 5 shelves and 12 or 16 dividers (3 per 36" wide section, 4 per 48").

The 74" high unit includes 6 shelves and 15 or 20 dividers (3 per 36" wide section, 4 per 48").

| Size D" x L" x H" | Capacity 750ml Bottles | Chrome Model No. | Weight lbs. |
|-------------------|------------------------|------------------|-------------|
| 14x36x63          | 144                    | TS-BW1436C6-KIT  | 104         |
| 14x48x63          | 192                    | TS-BW1448C6-KIT  | 122         |
| 14x36x74          | 180                    | TS-BW1436C7-KIT  | 121         |
| 14x48x74          | 240                    | TS-BW1448C7-KIT  | 141         |

| Additional Wine Shelves |   |           |      |
|-------------------------|---|-----------|------|
| 14x36                   | - | TS-S1436C | 8    |
| 14x48                   | - | TS-S1448C | 10.5 |

| Additional Accessories |                             |  |   |
|------------------------|-----------------------------|--|---|
|                        | TS-Bulk Dividers - BWD      |  | 2 |
|                        | TS-Foot Plate (each) - FPFT |  | 1 |
|                        | TS-Post Wall Bracket - PWB  |  | 1 |

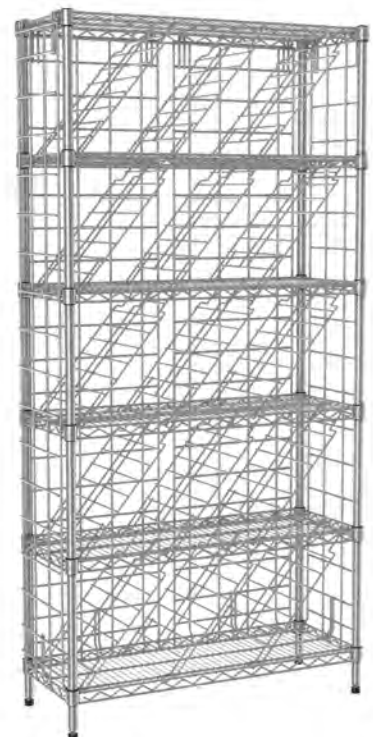

# Retail Solutions

## Wine Bottle Display Rack

Designed for both restaurant and retail applications, Stat Medical's Wine Bottle Display Rack offers an attractive and effective storage solution.

Each rack includes four posts with foot plates and wire cradle shelves with clips, providing a stylish display for your wine bottles.



| Size<br>D" x L" x H" | Cradle<br>Shelves | Capacity<br>750ml Bottles | Chrome<br>Model No. | Weight<br>lbs. |
|----------------------|-------------------|---------------------------|---------------------|----------------|
| 14x24x34             | 5                 | 30                        | TS-WR1424C3-KIT     | 38             |
| 14x30x34             | 5                 | 35                        | TS-WR1430C3-KIT     | 43             |
| 14x36x34             | 5                 | 45                        | TS-WR1436C3-KIT     | 48             |
| 14x48x34             | 5                 | 60                        | TS-WR1448C3-KIT     | 58             |
| 14x24x54             | 9                 | 54                        | TS-WR1424C5-KIT     | 60             |
| 14x30x54             | 9                 | 63                        | TS-WR1430C5-KIT     | 69             |
| 14x36x54             | 9                 | 81                        | TS-WR1436C5-KIT     | 78             |
| 14x48x54             | 9                 | 108                       | TS-WR1448C5-KIT     | 96             |
| 14x24x74             | 14                | 84                        | TS-WR1424C7-KIT     | 89             |
| 14x30x74             | 14                | 98                        | TS-WR1430C7-KIT     | 103            |
| 14x36x74             | 14                | 126                       | TS-WR1436C7-KIT     | 133            |
| 14x48x74             | 4                 | 168                       | TS-WR1448C7-KIT     | 145            |

### Additional Wine Shelves

|       |   |    |            |   |
|-------|---|----|------------|---|
| 14x24 | - | 6  | TS-WCS1424 | 5 |
| 14x30 | - | 7  | TS-WCS1430 | 6 |
| 14x36 | - | 9  | TS-WCS1436 | 7 |
| 14x48 | - | 12 | TS-WCS1448 | 9 |

Shelves and posts can be ordered separately for any configuration, including floor and tabletop units.

## Dump Bin Dolly Base

Transform your free-standing Dump Bin Merchandiser into a mobile unit with a Dump Bin Dolly Base.

Simply attach it to your existing setup to enhance mobility. Please note that one 20" deep bottom dump bin shelf is required for assembly. Plate casters are sold separately.

| Size<br>D" x L" | Chrome<br>Model No. | Weight<br>lbs. |
|-----------------|---------------------|----------------|
| 20x36           | TS-DBDB2036C        | 18             |
| 20x48           | TS-DBDB2048C        | 21             |

### Plate Casters

|                                |           |     |
|--------------------------------|-----------|-----|
| 5" Swivel Plate Caster         | TS-C5PPS  | 2.5 |
| 5" Swivel Plate Caster w/brake | TS-C5PPSB | 2.5 |

Casters are non-marking polyurethane

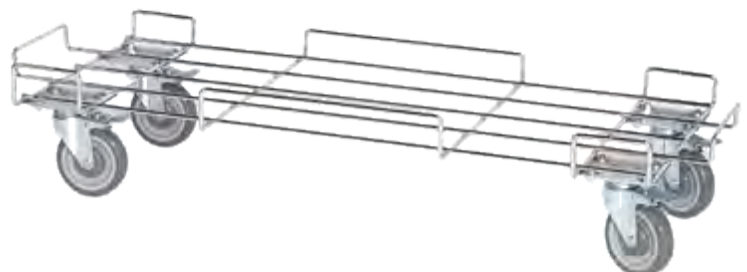

Item eligible for special orders 

# Retail Solutions

## Dump Bin Merchandiser

Featuring a full view open design modular system, allowing for easy access and inventory control at a glance. It can be positioned side by side or back to back for flexible configuration.

The stationary unit comes complete with one 20" bin, two 18" bins, and two 16" bins. Each bin has a weight capacity of 100 lbs. The Mobile Unit includes the same, as well as a Dolly Base and Casters, two with brakes, for convenient mobility.

Item eligible for special orders 



TS-DBMU48C

| Size<br>D" x L" x H"          | Chrome<br>Model No. | Weight<br>lbs. |
|-------------------------------|---------------------|----------------|
| <b>Stationary Unit</b>        |                     |                |
| 18x36x45                      | TS-DBMU36C          | 56             |
| 18x48x45                      | TS-DBMU48C          | 71             |
| <b>Mobile Unit</b>            |                     |                |
| 18x36x52                      | TS-MDBMU36C         | 80             |
| 18x48x52                      | TS-MDBMU48C         | 98             |
| <b>Additional Bin Shelves</b> |                     |                |
| 16x36x9                       | TS-DBM1636C         | 10             |
| 16x48x9                       | TS-DBM1648C         | 13             |
| 18x36x9                       | TS-DBM1836C         | 11             |
| 18x48x9                       | TS-DBM1848C         | 14             |
| 20x36x9                       | TS-DBM2036C         | 14             |
| 20x48x9                       | TS-DBM2048C         | 17             |

Dump Bin Dividers sold separately



Stationary Dump Bin Merchandiser A shown with optional dividers

## Dump Bin Dividers

- Three convenient sizes from which to choose
- Easy to install and keeps products organized

| Size<br>D" x H" | Chrome<br>Model No. | Weight<br>lbs. |
|-----------------|---------------------|----------------|
| 16x8            | TS-DBD168C          | 2              |
| 18x8            | TS-DBD188C          | 2              |
| 20x8            | TS-DBD208C          | 2              |



# Retail Solutions

## Slanted Shelf Merchandiser

Designed with a unique end truss to prevent products from falling off and increase stability, the Slanted Shelf Merchandiser is perfect for various applications such as industrial storage, school feeding programs, medical stores, and grocery stores.

These merchandisers offer visibility and easy access, featuring four shelves with plastic clips and four posts. The mobile unit includes four 5" swivel casters, two with brakes, for added convenience.

Item eligible for special orders 



| Size<br>D" x L" x H"              | Chrome<br>Model No. | Weight<br>lbs. |
|-----------------------------------|---------------------|----------------|
| <b>Stationary Unit</b>            |                     |                |
| 18x24x54                          | TS-SSU18245C        | 48             |
| 18x36x54                          | TS-SSU18365C        | 54             |
| 18x48x54                          | TS-SSU18485C        | 62             |
| 18x60x54                          | TS-SSU18605C        | 82             |
| 18x24x63                          | TS-SSU18246C        | 48             |
| 18x36x63                          | TS-SSU18366C        | 54             |
| 18x48x63                          | TS-SSU18486C        | 62             |
| 18x60x63                          | TS-SSU18606C        | 82             |
| <b>Mobile Unit</b>                |                     |                |
| 18x24x60                          | TS-MSSU18245C       | 58             |
| 18x36x60                          | TS-MSSU18365C       | 64             |
| 18x48x60                          | TS-MSSU18485C       | 72             |
| 18x60x60                          | TS-MSSU18605C       | 92             |
| 18x24x69                          | TS-MSSU18246C       | 58             |
| 18x36x69                          | TS-MSSU18366C       | 64             |
| 18x48x69                          | TS-MSSU18486C       | 72             |
| 18x60x69                          | TS-MSSU18606C       | 92             |
| <b>Additional Slanted Shelves</b> |                     |                |
| 18x24                             | TS-SS1824C          | 8              |
| 18x36                             | TS-SS1836C          | 9.5            |
| 18x48                             | TS-SS1848C          | 12             |
| 18x60                             | TS-SS1860C          | 17             |

Create your own custom configuration with casters and decor panels for specific merchandising needs



Unique end truss prevents products from falling off and provides increased stability



# Accessories

## Shelf Ledge

The Shelf Ledge is designed to protect valuable inventory from falling off the edge of the shelf. It easily snaps onto the perimeter of the shelf, creating a 1" or 4" high retaining edge.

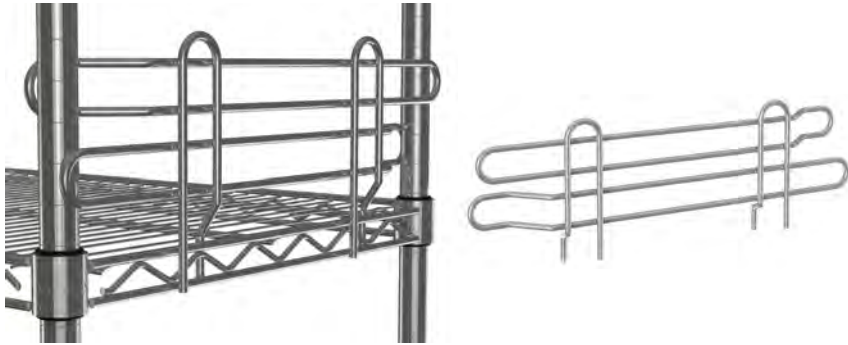

| Size W" | 1" High Model No. | 4" High Model No. |
|---------|-------------------|-------------------|
| 14      | TS-SL114C         | TS-SL414C         |
| 18      | TS-SL118C         | TS-SL418C         |
| 21      | TS-SL121C         | TS-SL421C         |
| 24      | TS-SL124C         | TS-SL424C         |
| 30      | TS-SL130C         | TS-SL430C         |
| 36      | TS-SL136C         | TS-SL436C         |
| 42      | TS-SL142C         | TS-SL442C         |
| 48      | TS-SL148C         | TS-SL448C         |
| 54      | TS-SL154C         | TS-SL454C         |
| 60      | TS-SL160C         | TS-SL460C         |
| 66      | TS-SL166C         | TS-SL466C         |
| 72      | TS-SL172C         | TS-SL472C         |

Shelves sold separately

## Shelf Divider

Stat Medical's Shelf Dividers keep shelves organized effortlessly, snapping in place without the need for tools. They can be attached at any point along the shelf, providing flexibility and convenience.

| Size W" x H" | Chrome Model No. | Size W"xH" | Chrome Model No. |
|--------------|------------------|------------|------------------|
| 14x4         | TS-SD414C        | 14x8       | TS-SD814C        |
| 18x4         | TS-SD418C        | 18x8       | TS-SD818C        |
| 21x4         | TS-SD421C        | 21x8       | TS-SD821C        |
| 24x4         | TS-SD424C        | 24x8       | TS-SD824C        |
| 24x6         | TS-SD624C        | x          | x                |

Shelves sold separately

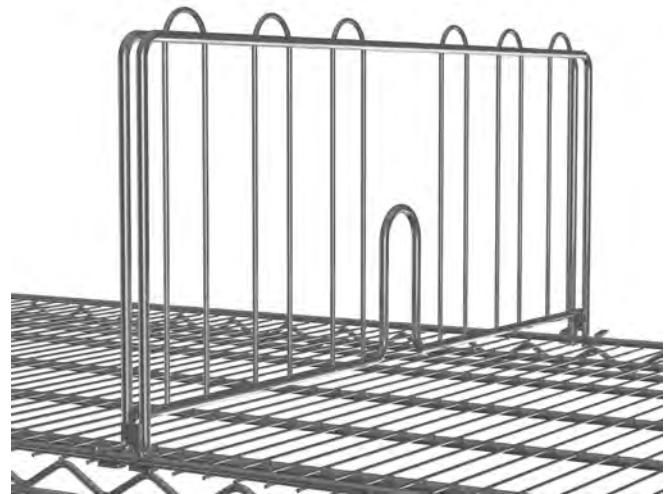

## Tray Slide Inserts

Perfect for mobile shelving units and carts, Tray Slide Inserts are invaluable space savers.

They allow trays and tote pans to be suspended between shelves, maximizing storage efficiency. With full-size slides designed to fit between any 18" and 24" deep wire shelves when spaced 22" apart, these inserts offer convenient organization with 1½" spacing between slides.

| Size W" x H" | Description                 | Chrome Model No. | Weight Lbs. |
|--------------|-----------------------------|------------------|-------------|
| 18x18        | 18" x 18" Tray Slide        | TS-TS18Z         | 10          |
| 24x24        | 24" x 24" Tray Slide        | TS-TS24Z         | 12          |
| 18x18        | 18" x 18" Single Tray Slide | TS-ST518Z        | 2           |
| 24x24        | 24" x 24" Single Tray Slide | TS-ST524Z        | 2           |

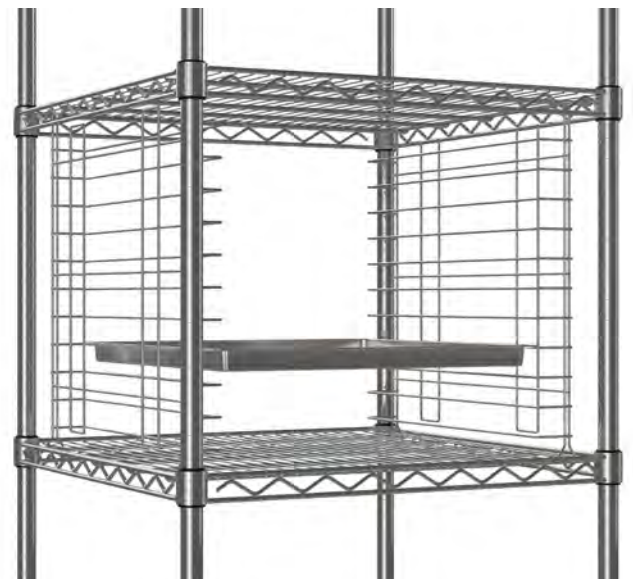

# Accessories

## Hanger Rail

The Hanger Rail is designed to fit on posts along the shelf width or length, providing flexible hanging solutions. Easily customize the rail by attaching hooks and other accessories for convenient access and organization.

| Size W" | Model No. | Size W" | Model No. |
|---------|-----------|---------|-----------|
| 14      | TS-HR14C  | 42      | TS-HR42C  |
| 18      | TS-HR18C  | 48      | TS-HR48C  |
| 21      | TS-HR21C  | 54      | TS-HR54C  |
| 24      | TS-HR24C  | 60      | TS-HR60C  |
| 30      | TS-HR30C  | 66      | TS-HR66C  |
| 36      | TS-HR36C  | 72      | TS-HR72C  |



## Enclosure Panel

These panels are designed to enclose the sides and backs of shelving units, preventing products from falling off and ensuring secure storage.

| Size W" x H" | Chrome Model No. | Polyseal Model No. |
|--------------|------------------|--------------------|
| 14x63        | TS-EP1463FLC     | TS-EP1463FLZ       |
| 14x74        | TS-EP1474FLC     | TS-EP1474FLZ       |
| 18x63        | TS-EP1863FLC     | TS-EP1863FLZ       |
| 18x74        | TS-EP1874FLC     | TS-EP1874FLZ       |
| 24x63        | TS-EP2463FLC     | TS-EP2463FLZ       |
| 24x74        | TS-EP2474FLC     | TS-EP2474FLZ       |

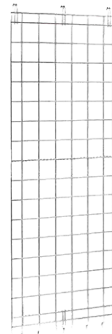

## Hanging & Stacking Bins

Keep things organized with Stat Medical's Bins. These heavy-duty, high-density Polypropylene bins can be stacked or hung from shelves, rails, or frames. They are waterproof, rustproof, and easily washable with soap and water. Additional sizes are available upon request with a minimum order quantity of 20 units. Custom colors are also available upon request.

Bin Holder Rail



## Three Sided & Four Sided Open Frames

These frames provide additional support and versatility for your shelving system. Use them to hang accessories or add enclosure panels as needed for customized storage solutions.

| Size W" x H" | Three Side Model No. | Four Side Model No. |
|--------------|----------------------|---------------------|
| 18x36        | TS-HR31836C          | TS-HR41836C         |
| 18x48        | TS-HR31848C          | TS-HR41848C         |
| 18x60        | TS-HR31860C          | TS-HR41860C         |
| 24x24        | TS-HR32424C          | TS-HR42424C         |
| 24x36        | TS-HR32436C          | TS-HR42436C         |
| 24x48        | TS-HR32448C          | TS-HR42448C         |
| 24x60        | TS-HR32460C          | TS-HR42460C         |



## Bin Holder Rail

The Bin Holder Rail is designed for use with Stat Medical's Hanging and Stacking Bins, providing a sturdy and reliable way to hang bins off the rail. This rail maximizes storage space while keeping bins easily accessible and organized.

| Size W" x H" | Model No. |
|--------------|-----------|
| 36" x 3"     | TS-BH36ZC |
| 48" x 3"     | TS-BH36ZC |



| Size D" x L" x H"   | Model No.      | Image |
|---------------------|----------------|-------|
| 10-7/8 x 11 x 5"    | TS-HSB11510BLU |       |
| 10-7/8 x 11 x 5"    | TS-HSB11510RED |       |
| 10-7/8 x 11 x 5"    | TS-HSB11510YEL |       |
| 10-7/8 x 5-1/2 x 5" | TS-HSB05510BLU |       |
| 10-7/8 x 5-1/2 x 5" | TS-HSB05510RED |       |
| 10-7/8 x 5-1/2 x 5" | TS-HSB05510YEL |       |



# Accessories

## Rods and Clips

Rods and Clips offer an easy solution for enclosing the back and/or sides of shelving units. Each rod comes with four chrome-finish clips, allowing for custom configurations. Additionally, Plastic Tabs are available to hold interior rods securely in place.

| Size L"                                    | Description              | Chrome Model No. | Weight Lbs. |
|--|--------------------------|------------------|-------------|
| 52   | Chrome rod fits 54" post | TS-ROD52         | 1           |
| 61   | Chrome rod fits 63" post | TS-ROD61         | 1.5         |
| 72   | Chrome rod fits 74" post | TS-ROD72         | 2           |
| 84   | Chrome rod fits 86" post | TS-ROD84         | 2.5         |
| -  | Plastic Tab              | TS-PTAB          | -           |
| Additional clips are packaged by the dozen |                          | TS-RODCLIPS      | 1           |

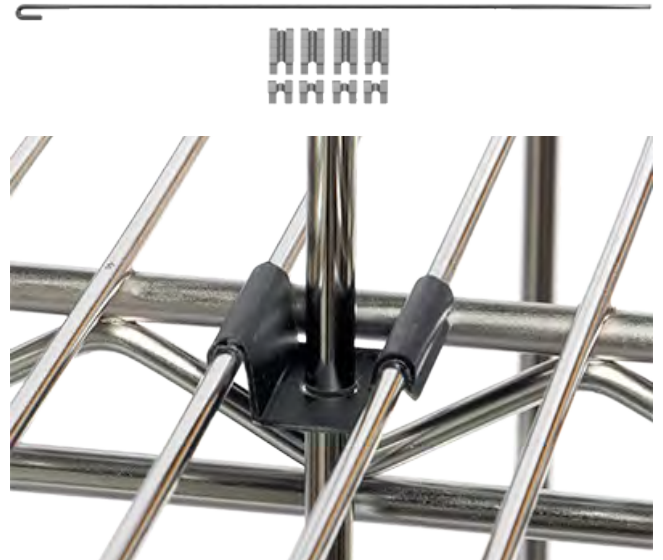

## Shelf Clips and Grounding Chain

The interlocking Plastic Shelf Clip features an interior mating rib to guarantee a secure shelf position, with an arrow indicating the correct orientation. For high-heat environments requiring static electrical conductivity, the Aluminum Shelf Clip can be used in conjunction with an optional Grounding Chain. The Grounding Chain provides a reliable path to ground wire shelving units, protecting sensitive electronic components from damage caused by electrostatic discharge.

| Size                                       | Model No. |
|--|-----------|
| 1" High Plastic Shelf Clip<br>Package of 4 | TS-PSC    |
| 1" High Aluminum<br>Shelf Clip - each      | TS-ASC    |
| 8" Long Grounding Chain                    | TS-GC8    |



## Add-On S-Hooks

Use two S-Hooks for each add-on wire shelf to connect them securely. These S-Hooks enable various configurations, allowing you to create L-shaped shelving units in corners, back-to-back units, or continuous runs of shelving. Each S-Hook provides stable attachment by going over the edge of the supported shelf and under the edge of the add-on shelf.

| Size H" | Chrome Model No. |
|---------|------------------|
| 1"      | TS-ADSH          |



**S-Hooks sold individually. Shown on L-shaped Add-On Shelving Unit.**

# Accessories

## Post Kit

The Post Kit provides a versatile solution for maximizing wall space, with adjustable post wall mount brackets and shelves that can be positioned at 1" increments. For extended shelving, multiple sections can be created using three or more Post Kits, with single shelf brackets at the ends and double shelf brackets on the center post kit. Each Post Kit includes one post and a parts kit for wall mounting, ensuring easy installation.

| Size H" | Chrome Model No. | Polyseal Model No. | Weight lbs. |
|---------|------------------|--------------------|-------------|
| 14      | TS-PK14C         | TS-PK14Z           | 2           |
| 34      | TS-PK34C         | TS-PK34Z           | 4           |
| 54      | TS-PK54C         | TS-PK54Z           | 6           |
| 63      | TS-PK63C         | TS-PK63Z           | 6           |

For assembly instructions visit [www.statmedicalcanada.com](http://www.statmedicalcanada.com)

| Size D" | Single Chrome Model No. | Single Polyseal Model No. | Single Polyseal Model No. | Weight lbs. |
|---------|-------------------------|---------------------------|---------------------------|-------------|
| 18      | TS-APB14S               | TS-APB14ZS                | TS-APB14CD                | 2           |
| 14      | TS-APB18S               | TS-APB18ZS                | TS-APB18CD                | 2           |
| 21      | TS-APB21S               | TS-APB21ZS                | TS-APB21CD                | 2           |
| 24      | TS-APB24S               | TS-APB24ZS                | TS-APB24CD                | 2           |

Order two Post Kits per unit and two Post Shelf Brackets per shelf.  
Shelves sold separately

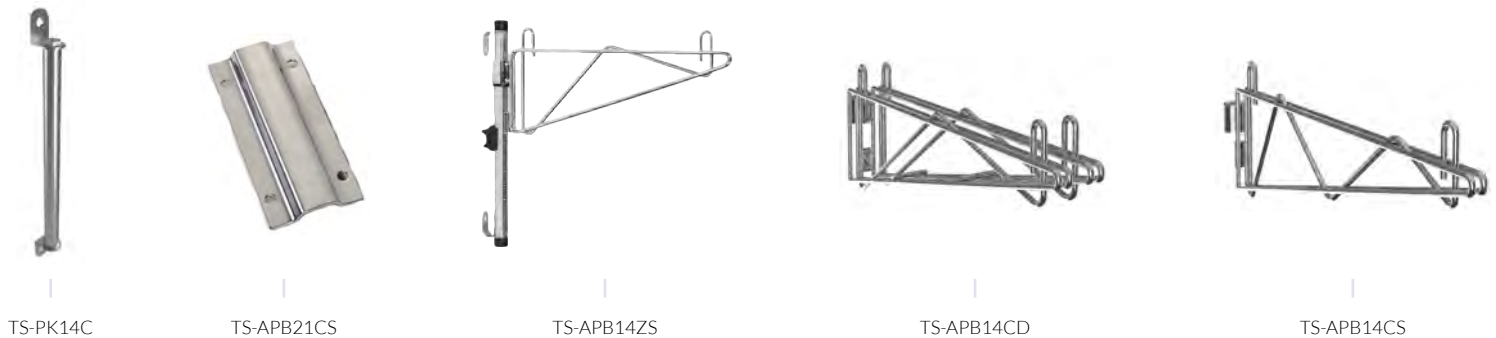

## Wall Mount Bracket

The Wall Mount Bracket is perfect for creating wall storage in areas with limited floor space. Two wall brackets are needed per shelf. For side-by-side shelving, use two single shelf brackets overlapped to connect the shelves.



Use two single shelf brackets overlapped to bank two shelves together, side-by-side.

| Size D" | Single Chrome Model No. | Single Polyseal Model No. | Weight lbs. |
|---------|-------------------------|---------------------------|-------------|
| 18      | TS-SWB14C               | TS-SWB14Z                 | 2           |
| 14      | TS-SWB18C               | TS-SWB18Z                 | 2           |
| 21      | TS-SWB21C               | TS-SWB21Z                 | 2           |
| 24      | TS-SWB24C               | TS-SWB24Z                 | 2           |

Order two Wall Mount Brackets per shelf.  
Shelves sold separately

## Ceiling Suspension Kit

The Ceiling Suspension Kit provides a solution for mid-room ceiling suspension or additional wall mount support. It includes a 120" threaded rod with hardware to secure the rod to the shelf collar (ceiling mounting not included). Rods and hardware are sold individually; four rods are needed for mid-room use, while two rods are sufficient for extra wall mount support.

| Size        | Model No. | Weight lbs. |
|-------------|-----------|-------------|
| 120" x 0.5" | TS-TRK    | 5           |



# Accessories

## Wall Grid Planner

Maximize wall storage space with the versatile Wall Grid Planner, perfect for hanging utensils and other items. (Note: unit may vary slightly from the image shown.)

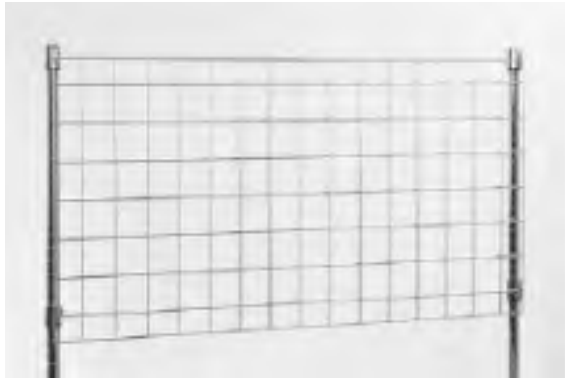

| Size H" x W"   | Polyseal Model No. | Weight lbs. |
|--|--------------------|-------------|
| <b>Wall Grid</b>   |                    |             |
| 22x36  | TS-WG2236Z         | 4           |
| 22x42  | TS-WG2242Z         | 5           |
| 22x48  | TS-WG2248Z         | 6           |
| 22x54  | TS-WG2254Z         | 7           |
| 22x60  | TS-WG2260Z         | 8           |
| 22x66  | TS-WG2266Z         | 9           |
| 22x72  | TS-WG2272Z         | 10          |
| <b>Mounting Brackets</b>   |                    |             |
| Wall Mount   | TS-WGBZ            | 1           |
| Post Mount   | TS-SGH1            | 1           |
| <b>Mounting Brackets sold individually, 4 recommended per Wall Grid.</b> |                    |             |

## Wall Grid Planner Accessories

Customize your Wall Grid Planner and stay organized with a range of Stat Medical Wall Grid Planner Accessories.



TS-WCCZ



TS-WGBZ



TS-SCH1

| Size W" x D" x H" | Model No.   | Description               |
|-------------------|-------------|---------------------------|
| N/A               | TS-WGBZ     | Wall Grid Bracket         |
| N/A               | TS-SCH1     | Post Mount Grid Bracket   |
| N/A               | TS-WCCZ     | Wall Grid Clip            |
| 12x12             | TS-SGS1212Z | Small Polyseal Grid Shelf |
| 12x24             | TS-SGS1214Z | Large Polyseal Grid Shelf |
| 12.375x2x8.63     | TS-DH       | Chrome Document Holder    |
| 3x3x12            | TS-SR       | Chrome Spice Rack         |
| 12x10x4           | TS-UB       | Utility Basket            |

## Grid Shelves

Stat Medical Grid Shelves provide a convenient way to hold items and accessories. Easily movable along the grid, they can be positioned perfectly for any task. Available in 12"x12" (Model No. TS-SGS1212Z) and 12"x24" (Model No. TS-SGS1224Z) sizes.



## Document Holder

The Document Holder (Model No. TS- DH) securely holds 8½" documents and can be attached to any wire shelf, hanger rail, or grid for easy accessibility.

## Spice Rack

Stat Medical's Spice Rack (Model No. TS-SR) is perfect for keeping spices and other small items organized. It can be attached to any shelf, hanger rail, or grid for easy accessibility. The interior dimensions are 3" H x 4" D x 12" L.

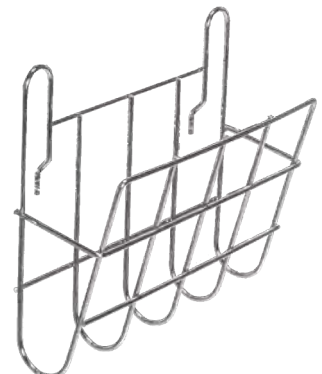

# Accessories

## Hooks

Discover convenience with Stat Medical's range of Hooks. These multi-purpose snap-on J-Hooks are designed to hang effortlessly on shelves, grid panels, or hanger rails, offering easy access to items.

| Size H"            | Model No. |
|--------------------|-----------|
| 3½" Small J-Hooks  | TS-SJH    |
| 3½" Large J-Hooks  | TS-LJH    |
| 3½" Double J-Hooks | TS-DJH    |
| 3" Wire S-Hook     | TS-WSH    |

Hooks sold individually.



— TS-SJH



— TS-LJH



— TS-DJH



— TS-WSH

## Shelf Beam Support

Enhance the load-bearing capacity of traditional wire shelves with our Shelf Beam Supports. Designed for heavy loads, each kit includes two beams complete with hardware for easy installation and added strength.

| Size H"  | Model No.  |
|----------|------------|
| 30" x 1" | TS-SBS30ZC |
| 36" x 1" | TS-SBS36ZC |
| 48" x 1" | TS-SBS48ZC |
| 54" x 1" | TS-SBS54ZC |
| 60" x 1" | TS-SBS60ZC |
| 66" x 1" | TS-SBS66ZC |
| 72" x 1" | TS-SBS72ZC |



## Shelf Collar Hook

Effortlessly transform straight shelves into slanted ones with Shelf Collar Hooks to enhance visibility and easier access to goods. These hooks are also perfect for hanging tools and utensils from Stat Medical Posts, adding versatility to your storage solutions. Moreover, they can be used to securely hold grids in place.

| Size                        | Chrome Model No. |
|-----------------------------|------------------|
| ½" Small Shelf Collar Hook  | TS-SCH1          |
| 1½" Large Shelf Collar Hook | TS-SCH2          |



TS-SCH1



TS-SCH2

## Replacement Post Cap

Complete the look of your shelving unit with our Plastic Post Caps. Simply place them on top of the posts for a polished finish. These caps come standard with all Stat Medical Posts

| Chrome Model No. |
|------------------|
| TS-PPC           |



## Non-Marking Post Leveler

Designed to provide sturdy support, these levelers come standard with all Stat Medical posts, offering both liability and floor protection.

| Chrome Model No. |
|------------------|
| TS-NMPL1/2       |

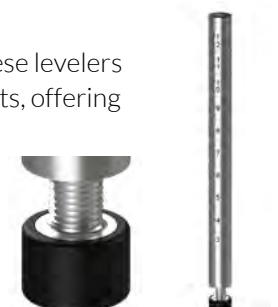

# Accessories

## Post Insert

Maintain the stability of your Stat Medical shelving units, regardless of uneven floors, with our Post Inserts. These inserts are included standard with all Stat Medical posts, ensuring your shelves remain level and sturdy. Replacement inserts available for individual purchase.



| Description        | Model No. |
|--------------------|-----------|
| Post Insert        | TS-PI12   |
| Post Insert - 2.5" | TS-PI212  |

## Post Joining Clamp

Enhance the stability of shelving units by securely joining two posts together with the Post Joining Clamp. Ideal for use with Stat Medical Space Tite systems and when banking together is required, this clamp ensures a solid connection for increased durability and reliability.



| Description           | Model No. |
|-----------------------|-----------|
| Creates 1 1/16" space | TS-SPC    |
| Creates 2" space      | TS-LPC    |

## Foot Plate

Boost stability and safety with Foot Plates, designed to enhance the stability of shelving units. This plate allows for easy bolting to the floor, ensuring a secure installation. Recommended for use with Stat Medical Space Tite systems, it provides added support for safety.



| Chrome Model No. |
|------------------|
| TS-FPFT          |

## Post Extension Bolt

Easily extend the height of a shelving unit with Post Extension Bolts. This bolt securely joins two posts from top to bottom, providing a seamless extension for increased storage capacity.



| Chrome Model No. |
|------------------|
| TS-PEB           |

## Utility Basket

Effortlessly store or transport documents and other items with the convenient Utility Basket. Designed to slide easily over Stat Medical shelving frames, it provides a secure fit for versatile storage solutions.



| Size L" x W" x H" | Chrome Model No. |
|-------------------|------------------|
| 12x10x4           | TS-UB            |

# Accessories

## Chrome Handles

Crafted for enhanced usability and hand safety, our Chrome Handles are designed to keep users' hands comfortably within the cart width. Experience added convenience and peace of mind during transport and maneuvering with these sturdy and ergonomic handles.

| Size D" | Model No. | Model No. | Weight lbs. |
|---------|-----------|-----------|-------------|
| 14      | TS-SPH14C | TS-PH14C  | 2           |
| 18      | TS-SPH18C | TS-PH18C  | 2           |
| 21      | TS-SPH21C | TS-PH21C  | 2.5         |
| 24      | TS-SPH24C | TS-PH24C  | 3           |



## Label Holder

Effortlessly label shelves for quick product identification with Stat Medical's Label Holders. Crafted from black plastic, it snaps easily onto the shelf edge, providing a convenient solution for organizing and categorizing your items.



| Size W" | Model No. | For Shelf Length |
|---------|-----------|------------------|
| 3       | TS-CLH3B  | All              |
| 7.25    | TS-CLH7B  | All              |
| 12      | TS-CLH12B | All              |
| 19.25   | TS-CLH24B | 24"              |
| 31.25   | TS-CLH36B | 36"              |
| 43.25   | TS-CLH48B | 48"              |
| 55.25   | TS-CLH60B | 60"              |
| 67.25   | TS-CLH72B | 72"              |

Custom sizes available on request. Labels not included

## Wood Top Joiner

This handy accessory allows for quick and secure attachment of wood tops to shelving posts, eliminating the need to cut into wood tops. Mounting screws not included.

| Model No. |
|-----------|
| TS-WTJ    |

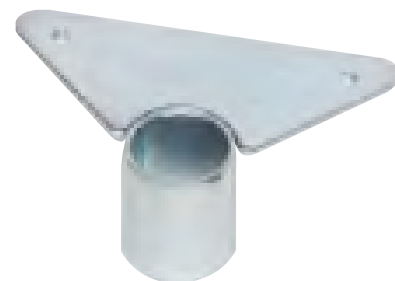

## Post Wall Bracket

Ensure stability and security by securely attaching posts to walls with Post Wall Brackets. Due to the variation of wall materials, mounting screws not included.

| Model No. |
|-----------|
| TS-PWB    |



# Index

|  |    |   |    |
|--|----|---|----|
| 3-Sided Frame                          | 9  | Post                                    | 5  |
| 4-Tier Starter Unit with Dunnage Base  | 16 | Post Joining Clamp                      | 37 |
| 5-Sided Shelf                          | 13 | Post Kit                                | 34 |
| 5-Tier Starter Unit                    | 15 | Post Insert                             | 37 |
| Add-On Unit                            | 14 | Post Extension Bolt                     | 37 |
| Add-On S Hooks                         | 33 | Post Wall Bracket                       | 38 |
| All Purpose Sorting Rack               | 21 | Quarter Round Shelf                     | 8  |
| Aluminum Milk Crate & Glass Rack Dolly | 19 | Replacement Post Cap                    | 36 |
| Apparel Cart                           | 24 | Rigid Casters                           | 6  |
| Beer Keg Rack                          | 17 | Round Shelf                             | 8  |
| Beverage Rack                          | 20 | Rods and Clips                          | 33 |
| Bulk Wine Bottle Storage               | 27 | Shelf Beam Support                      | 36 |
| Can Racks and Dispensers               | 20 | Shelf Clips and Grounding Chain         | 33 |
| Ceiling Suspension Kit                 | 34 | Shelf Collar Hook                       | 36 |
| Channel Dunnage Shelf                  | 10 | Shelf Overlays/Inlays                   | 15 |
| Channel Dunnage Rack                   | 18 | Shelf Ledge                             | 31 |
| Chrome Handles                         | 38 | Shelf Divider                           | 31 |
| Corner Starter Unit                    | 13 | Slanted Shelf Merchandiser              | 30 |
| Dunnage Shelf Mat                      | 10 | Solid Stainless Steel Shelf             | 8  |
| Dump Bin Merchandiser                  | 28 | Spice Rack                              | 35 |
| Dump Bin Dividers                      | 28 | Starter Unit                            | 11 |
| Dump Bin Dolly Base                    | 29 | Stainless Steel Knock Down Bun Pan Rack | 23 |
| Document Holder                        | 35 | Stationary & Mobile Security Units      | 26 |
| Donut Bumper                           | 6  | Stem Casters                            | 6  |
| Dolly Base                             | 26 | Super Duty Shelf                        | 9  |
| Enclosure Panel                        | 32 | The Corner Conqueror                    | 7  |
| Flex Mount Shelving                    | 7  | Tray Slide Inserts                      | 23 |
| Foot Plate                             | 37 | Tray Slide Inserts                      | 31 |
| Garment Rack                           | 25 | Triangular Shelf                        | 7  |
| Grid Shelf                             | 35 | Utility Rack                            | 17 |
| Hanger Rail                            | 32 | Utility Cart                            | 22 |
| Hanging & Stacking Bins                | 32 | Universal Bun Pan & Insert Pan Rack     | 23 |
| Hooks                                  | 36 | Utility Basket                          | 37 |
| Label Holder                           | 38 | Wall Garment Storage                    | 25 |
| Linen Cart                             | 24 | Wall Grid Planner                       | 35 |
| Linen Collection Cart                  | 25 | Wall Grid Planner Accesories            | 35 |
| Light Duty Display Rack                | 19 | Wall Mount Bracket                      | 34 |
| Lockers                                | 27 | Wire Lockers                            | 27 |
| Mail Room Delivery Cart                | 21 | Wire Shelves                            | 4  |
| Mobile Channel Dunnage Rack            | 18 | Wire Platform                           | 19 |
| Non-Marking Post Leveler               | 36 | Wine Bottle Display Rack                | 29 |
| Plate Casters                          | 6  | Wood Top Joiner                         | 38 |



**statmedical**  
we take care

## Shelving, Racks, Carts & Specialty Shelving **Vol. 24**



[www.statmedicalcanada.com](http://www.statmedicalcanada.com)

866.783.4076

[sales@statmedicalcanada.com](mailto:sales@statmedicalcanada.com)

10 Abbott Court Unit 201  
Brantford ON  
N3S 0E7